

7X50 RF Terminal TM

Portable Radio Frequency Terminal & Base Station



Worth Data[®]
Host Controlled
RF Terminal Bar Code
Scanning System for
the USA & Canada

RF Terminal Models:
LT7150H & LT7250H

Base Station Models:
B5011, B5021V, & B5021R

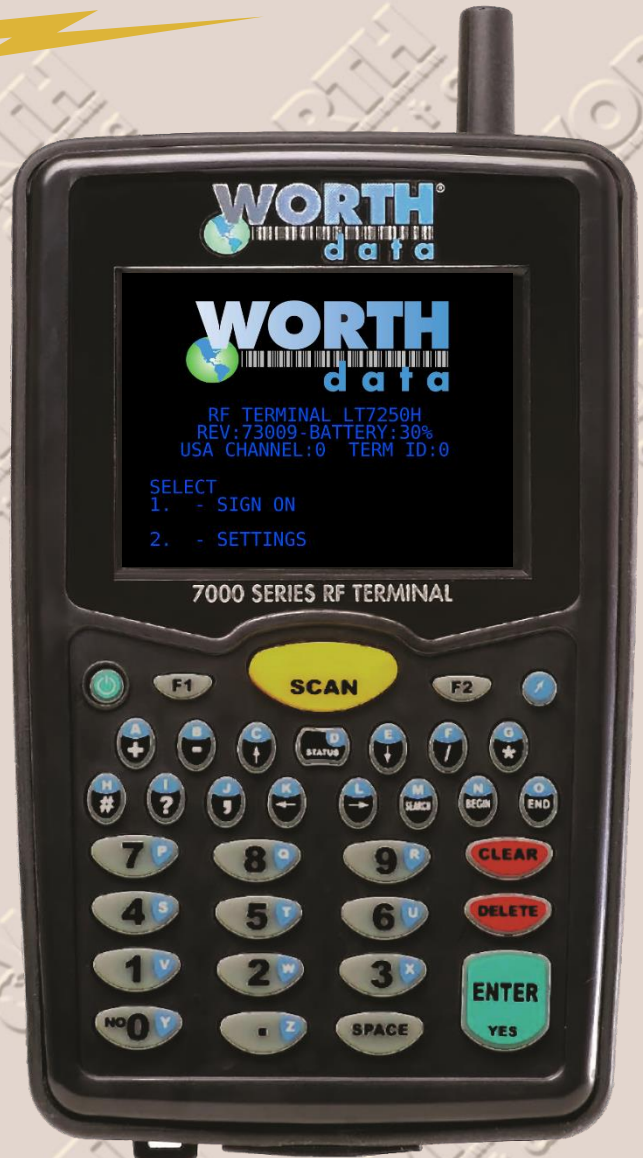

This equipment has been tested and found to comply with the limits for a Class B digital device, pursuant to Part 15 of the FCC Rules. These limits are designed to provide reasonable protection against harmful interference in a residential installation. This equipment generates uses and can radiate radio frequency energy and, if not installed and used in accordance with the instructions, may cause harmful interference to radio communications. However, there is no guarantee that interference will not occur in a particular installation. If this equipment does cause harmful interference to radio or television reception, which can be determined by turning the equipment off and on, the user is encouraged to try to correct the interference by one or more of the following measures:

- Reorient or relocate the receiving antenna
- Increase the separation between the equipment and receiver
- Connect the equipment into an outlet on a circuit different from that to which the receiver is connected
- Consult the dealer or an experienced radio/TV technician for help

Shielded cables must be used with this equipment to comply with the relevant FCC regulations. Changes or modifications not expressly approved in writing by Worth Data may void the user's authority to operate this equipment.

This device complies with Part 15 of the FCC Rules. Operation is subject to the following two conditions: (1) this device may not cause harmful interference, and 2) this device must accept any interference received, including interference that may cause undesired operation.

CAUTION:

Any changes or modifications not expressly approved by the grantee of this device could void the user's authority to operate the equipment.

RF Exposure warning

The equipment complies with FCC RF exposure limits set forth for an uncontrolled environment.

Innovation, Science and Economic Development Canada(ISED) Compliance Statement

This device complies with ISED's licence-exempt RSSs. Operation is subject to the following two conditions: (1) this device may not cause harmful interference, and (2) this device must accept any interference received, including interference that may cause undesired operation. Le présent appareil est conforme aux CNR d'ISED applicables aux appareils radio exempts de licence. L'exploitation est autorisée aux deux conditions suivantes : (1) le dispositif ne doit pas produire de brouillage préjudiciable, et (2) ce dispositif doit accepter tout brouillage reçu, y compris un brouillage susceptible de provoquer un fonctionnement indésirable.

Radio Frequency (RF) Exposure Information

The radiated output power of the Wireless Device is below the Innovation, Science and Economic Development Canada (ISED) radio frequency exposure limits. The Wireless Device should be used in such a manner such that the potential for human contact during normal operation is minimized. This device has also been evaluated and shown compliant with the IC RF Exposure limits under portable exposure conditions.

Informations concernant l'exposition aux fréquences radio (RF)

La puissance de sortie rayonnée de l'appareil sans fil est inférieure aux limites d'exposition aux radiofréquences d'Innovation, Sciences et Développement économique Canada (ISDE). L'Appareil sans fil doit être utilisé de telle manière que le potentiel de contact humain pendant le fonctionnement normal soit minimisé. Cet appareil a également été évalué et démontré conforme aux limites d'exposition RF IC dans des conditions d'exposition portables.

This device complies with RSS-210 of Industry Canada. Operation is subject to the following two conditions: 1) this device may not cause interference, and 2) this device must accept any interference, including interference that may cause undesired operation of the device. CAN ICES-003(B) / NMB-003(B)

The 7150, 7250 RF Terminals and B50X1 Base Station have been approved for use in the United States and Canada as a low power frequency hopping spread-spectrum radio operating in the unlicensed 915 MHz frequency range. FCC ID: JWSLT7150, IC: 4724A-LT7150



The 7150 RF Terminal models have a laser scanner integrated with the Terminal as one unit. The laser used is a Class II Laser Product and has a 1.0 Milliwatt Output. To operate the laser scanner, aim the top of the case at a bar code, and press the yellow scan key on the keyboard of the RF Terminal and/or the Trigger on the Handle. The light source will turn off, once a successful scan has occurred or 2.5 seconds has elapsed, whichever is first. Do not look directly into the laser light source with the "Scan Key" depressed; avoid direct eye contact with the laser light source.

Warning labels to **CAUTION LASER LIGHT – DO NOT STARE INTO BEAM** are located as shown on the left:

There are no user adjustments or maintenance operations to be performed on the integrated laser scanner. **Opening the Unit Will Void the Warranty. Caution - use of controls or adjustments or performance of procedures other than those specified herein may result in hazardous laser light exposure.**

Limited Warranty. (A) The workmanship for the applicable warranty period which starts from the date of shipment, provided the hardware product remains unmodified and is operated under normal and proper conditions. The sole obligation of Seller for defective Hardware Products is limited to repair or replacement (at Seller's option) on a 'return to factory' basis with prior Seller's authorization. Shipment to Seller will be at Buyer's expense, unless it is within 30 days after the initial shipment of the Product to a U.S. location, in which case the Seller will offer to have the equipment sent back with a call tag at Seller's expense. Seller will return replaced or repaired equipment within warranty at Seller's expense. No charge will be made for repair or replacement parts for Products under warranty. (B) The aforementioned provisions do not extend the original warranty period of any Product that had either been repaired or replaced by Seller. (C) the above warranty shall not apply to any Product (i) which has been repaired or altered, except by Seller; (ii) which has not been maintained in accordance with any operating or handling instructions supplied by Seller, or (iii) which has been subjected to unusual physical or electrical stress, misuse, abuse, negligence or accident. EXCEPT FOR THE WARRANTY OF TITLE AND THE EXPRESS WARRANTIES STATED ABOVE, SELLER DISCLAIMS ALL WARRANTIES ON PRODUCTS FURNISHED HEREUNDER INCLUDING ALL IMPLIED WARRANTIES OF MERCHANTABILITY AND FITNESS FOR A PARTICULAR USE. The stated express warranties are in lieu of all obligations or liabilities on the part of Seller for damages including but not limited to special or consequential damages arising out of or in connection with use or performance of the Product. Seller's liability for damages to Buyer or others resulting from the

use of any Product or Service furnished hereunder shall in no way exceed the purchase price of said product or the fair market value said service, except in instances of injury to persons or property. Products for which warranty period has expired will be repaired at the price of materials plus the hourly rate for labor applied. For warranty question or support contact Worth Data at 831-458-9938. RF Terminal & Base Station Products have a LIMITED WARRANTY of two years. Such warranty is against defects in materials and

- ▲ **WARNING:** Cables, Cable Assemblies, and Printed Circuit Boards can expose you to chemicals including lead and lead compounds which are known to the State of California to cause cancer and birth defects or other reproductive harm. For more information, go to www.P65Warnings.ca.gov
- ▲ **WARNING:** Lithium-ion Batteries and/or products that contain Lithium-ion Batteries can expose you to chemicals including cobalt lithium nickel oxide, and nickel, which are known to the State of California to cause cancer and birth defects or other reproductive harm. For more information, go to www.P65Warnings.ca.gov
- ▲ **WARNING:** Electrical cords, cables, product cords, wire assemblies, and carrying cases made with PVC can expose you to chemicals including DEHP, which are known to the State of California to cause cancer and birth defects or other reproductive harm. For more information, go to www.P65Warnings.ca.gov
- ▲ **WARNING:** Plastic cases and product plastic housings made from polycarbonate or other plastics can expose you to chemicals including bisphenol A (BPA), which are known to the State of California to cause cancer and birth defects or other reproductive harm. For more information, go to www.P65Warnings.ca.gov



Worth Data, Inc.
623 Swift St., Suite B
Santa Cruz, CA 95060

Table of Contents

Introduction.....	5
Compatibility with Older RF Terminals	5
Quick Start Guide	6
Step 1: System Overview	6
Step 2: Hardware Overview	6
Step 3: Connecting the RF Base to the Host Computer	7
Step 4: Installing Hardware Utilities 3.0	7
Step 5: Running Hardware Utilities 3.0	10
Chapter 1: <i>Installation</i>	13
Components	13
Installation Sequence	13
Connecting the Base Station	13
Installation.....	17
RF Terminal Operation	19
Recharging the RF Terminal Battery	20
Installing the Hardware Utilities 3.0 Software	22
Chapter 2: <i>RF Terminal Setup</i>	23
Bar Code Options.....	28
Scan Engine Options – LT7150H	33
Scan Engine Options – LT7250H	35
Date & Time Settings.....	36
Speaker Settings	36
LCD Options	37
Other Settings.....	38
System Tools.....	41
BT Portable Printer Settings:.....	42
Chapter 3: <i>Base Station & Relay Setup</i>.....	43
Base (B5011) and Relay Setup.....	43
Adding B5011 Relays	47
Base Station Cable Options.....	53
B5021V Connection – Direct Ethernet	54
B5021R Connection - Ethernet Relay	54
Ethernet Base (B5021) Setup	55
Chapter 4: <i>Operational Theory</i>.....	64
How the Two-Way RF System works.....	64
How One-Way Mode works	65
How Site Survey works.....	66
Chapter 5: <i>Site Tests</i>	67
Evaluating your area of planned operation.....	67
Chapter 6: <i>Programming</i>	69
Before you begin programming. . .	69

Failure Planning	70
Programming for the RF Terminal	71
Base Station Error Feedback	78
Control Keys for Possible Programming	80
ASCII Control Character and Extended ASCII Conversion (2D scanner only).....	80
Chapter 7: Programming Tools	81
Concepts - ActiveX Object Programming.....	81
Chapter 8: Portable Printers – BT Settings	84
Chapter 9: Voice Message Operations	85
Why Use Voice Messages and Prompts?	85
Voice Prompts and the Hardware Utilities 3.0 program	85
Tips for Using Voice Prompts.....	85
Chapter 10: Troubleshooting	87
General Considerations	87
Problems with a new installation:	88
RF Terminal Error Messages	89
Base LED Color Meaning	90
Troubleshooting specific problems	91
RF Terminal Problems	93
Problems reading Bar Codes	94
No Scan Beam.....	94
Problems with Voice Prompts.....	94
If you still have a problem.....	95
Chapter 11: Firmware Upgrades	96
RF Terminal Firmware Upgrades	96
Base Station Firmware upgrades.....	96
Appendix A: How to scan a bar code	97
1D Laser Scanners.....	97
2D Optical Imaging Scanners	98
ASCII Code Equivalent Table.....	99

Introduction

The LT7150H & LT7250H RF Terminals are the latest generation of the Worth Data 7000 Series RF Terminals. These are the industry leading low cost, easy-to-use radio frequency mobile handheld bar code scanning RF Terminals that communicate via a B50XX Base Station connected to a PC, or any computer, by USB, RS-232 serial port, or Ethernet. These RF Terminals offers unprecedented power and ease of use, while maintaining compatibility with programs written for the older Worth Data Terminals. The list of fantastic features includes:

- Up to 3 mile range, Line of Site (10 x the competition)
- 64 Terminals per Base Station
- Spread Spectrum frequency hopping avoids interference
- LT7X50H Radio is **compatible with all 7000 900Mhz units**
- No license required in USA and Canada
- Small size, (5.9" L, 3.6" W, 1.0" D)
- Designed to withstand multiple 5 ft. drops to concrete
- Long Battery Life (15 hours of usage)
- Fast Recharging (4-5 hours) via External F17 Power Supply
- No programming on terminal
- Host communication via USB, RS-232 Serial, or Ethernet
- Customizable Voice Prompting plus Display
- Backlit Color TFT Display
- Uses 5000mAh Li-Ion battery

The RF Terminal maintains software compatibility with applications written for the older generation Worth Data T71/LT71 and T701/LT701 RF Terminals. Differences are noted below.

Compatibility with Older RF Terminals

While the **7X50** series RF Terminals are fully software compatible and RF interchangeable with all of our 7000 series terminals and B50XX Base Stations, the older 700 and 70 series terminals (with B501 & B51 Bases) are not RF compatible – they are however software compatible, so you can use older existing software applications written for the older units.

The differences between the older 70/700 generation of Worth Data RF Terminals and the 7X50 units referred to within this manual are:

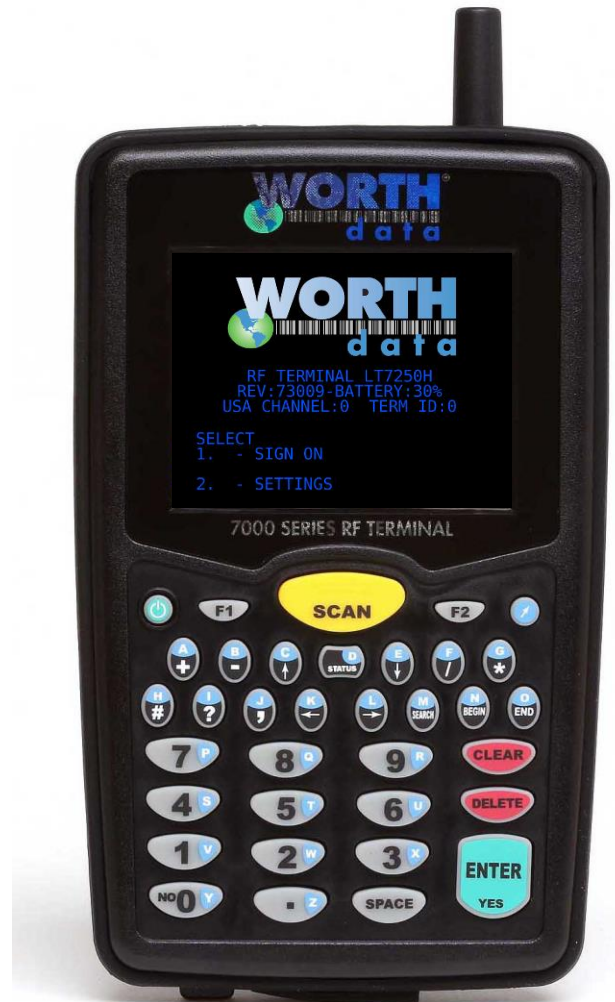

Quick Start Guide

This guide will give you a basic understanding of how the system functions and step through how to get the RF Terminal and RF Base up and running with a simple demo program.

Step 1: System Overview

The RF Terminal system consists of three main parts, the **RF Terminal**, the **Base Station** and the **application program** running on the host computer. The RF Base works much like any access point and allows multiple RF Terminals to interact with the host application program simultaneously. In a nutshell, the system operates as follows:

All communication between the host and terminal is initiated by the terminal (there are exceptions but this is the most common scenario). First the terminal “signs-in” to the host. This lets the host program know that a new terminal is active and ready to be used. The host responds by sending a prompt to the terminal. All communication passes through the base. The base keeps track of the data and makes sure that nothing gets lost. The terminal responds to the prompt with some data and the host responds to the data with another prompt. This process repeats over and over until there is no more data to be entered and the terminal is either “signed-out” or turned off.



Step 2: Hardware Overview

The most common implementation is a single **B5011 Base Station** connected to a host computer by a USB, or serial cable. Each base can communicate with multiple terminals and thus forms a “star” network with the base as the central “hub” funneling all data from the terminals to the host computer.

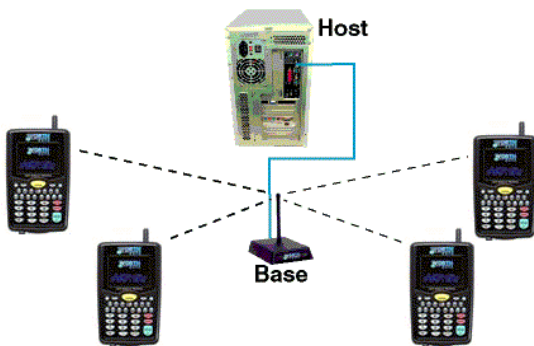

The high-powered radios used in the Base and Terminal have a range of up to 3 miles when used outdoors, without obstructions, and can easily cover a large warehouse indoors. However, if more range is required, Relays can be attached to the Base to extend the range further. This sometimes happens when the Base is located within a heavily shielded room or there is a great deal of RF blocking, or absorbing material, near the Base. The exact range is difficult to determine since there are so many variables to consider and every installation is different. The RF signal of our units is in the 915MHz frequency band and will not interfere with Wi-Fi radio devices and has considerably longer range.

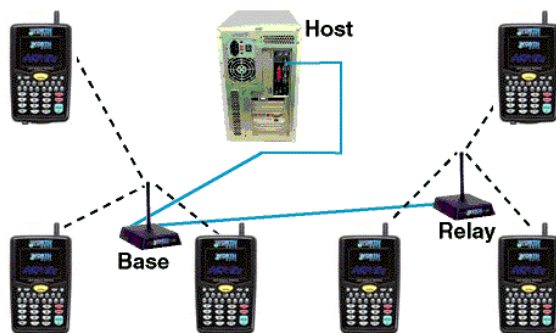

Step 3: Connecting the RF Base to the Host Computer

The **B5011 Base Station**, or **B5021R Base Station**, can be connected to the host computer by either a standard USB cable or a RS-232 serial cable. Looking at the back of the base you will see 4 connectors:

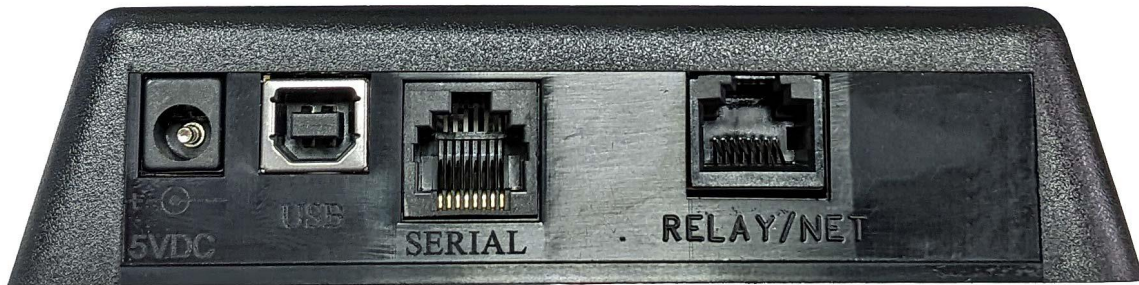

The simplest way to connect the **B5011 Base Station**, or **B5021R Base Station** to the host computer is with a USB cable, or a RS-232 cable to a COM port. If you will be using the USB port for communication refer to the [Chapter 3: Base Station Setup](#) for detailed information on how to connect the Base by USB and how to install the USB driver. A separate Worth Data 5VDC power supply is required when using a RS-232 cable. A power supply is *not required* if you are connecting by USB to a **full power USB Port** – if you connect to a low power USB port then you may need a Worth Data 5VDC power supply.

For serial connections, first plug the F36 RS-232 cable into an available serial COM port on the host PC, then plug the RJ45 plug into the SERIAL port on the back of the Base Station. Then plug in the 5VDC power supply and power up the Base. The LED on the front of the Base should **blink Green three times and then stay Green** – this means you are on RF Channel 0. If that's not the case then refer to [Chapter 3: Base Setup](#) or the [Troubleshooting section](#). No drivers are required for the SERIAL connection using a F36 cable.

Step 4: Installing Hardware Utilities 3.0

The *Hardware Utilities 3.0* program is available on our website at <https://www.barcodehq.com/downloads.html>. Look for the download link to our *Hardware Utilities 3.0*.

Once you have downloaded the program you will need to install it on your computer. Locate the **setupintegratedutils.exe** file and double click, or alt click and Open to start the installation. Note: You need to be the Administrator on the machine to install the software and drivers properly.

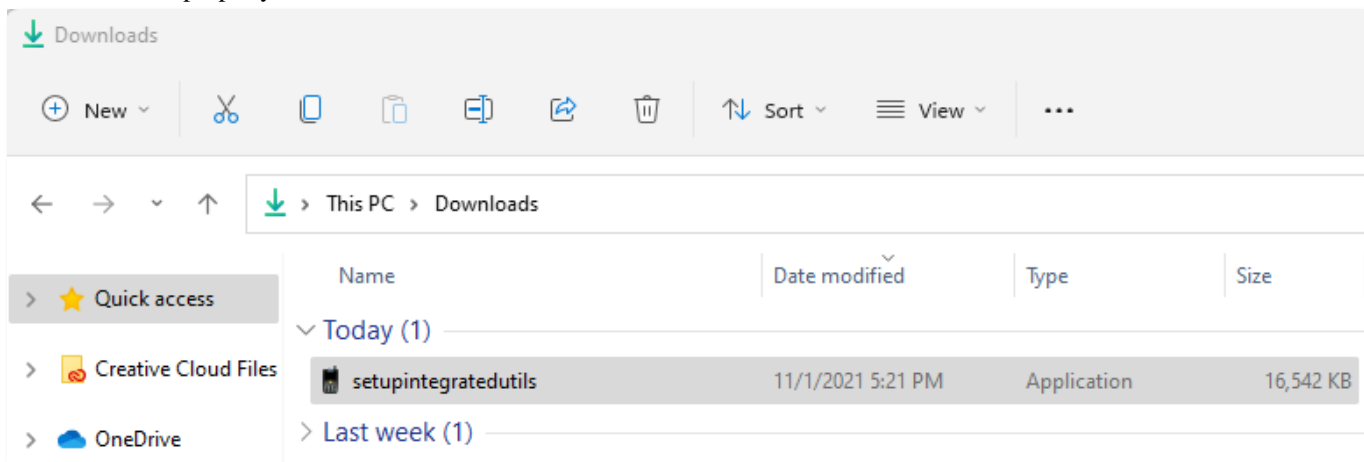

You should see the messages as shown below during the installation. Click on “Yes” to install the Hardware Utilities 3.0 Setup



Select the folder where you want to install the software and click Next, Then, use, or change the name of the Start Hardware Folder, **Worth Data Hardware** and click Next

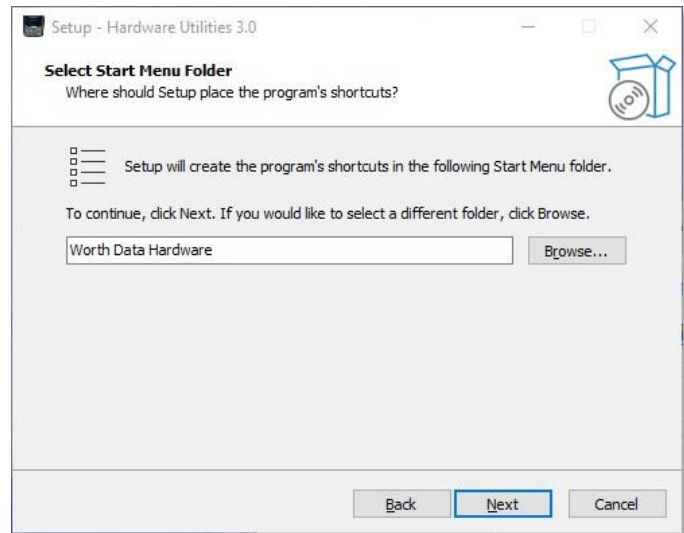
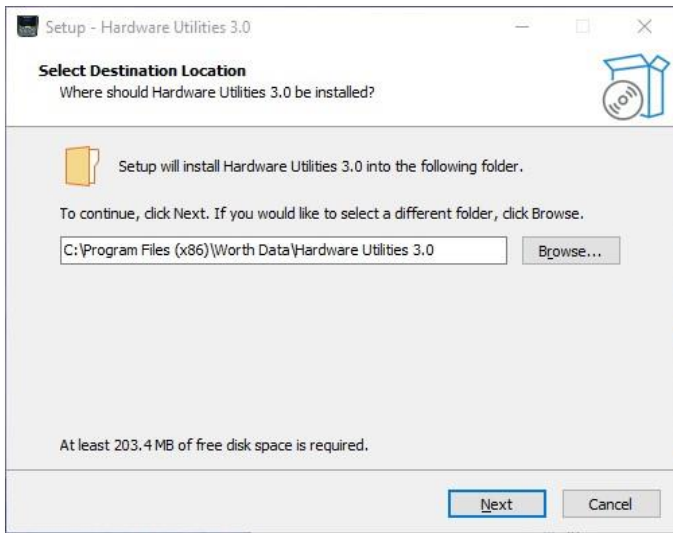

Click the Install button to install the software. The program will then install on your system.

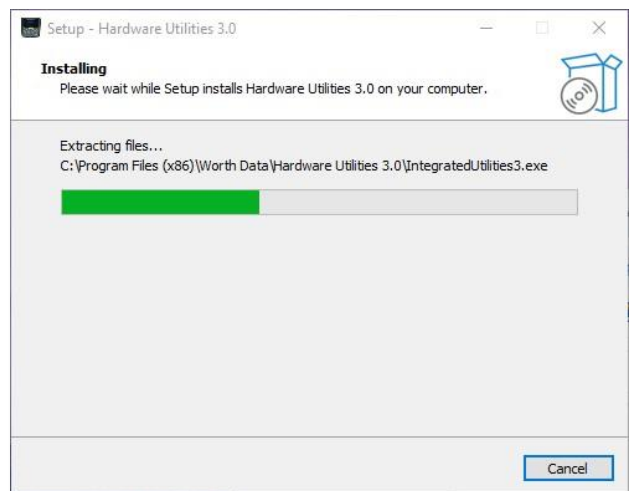
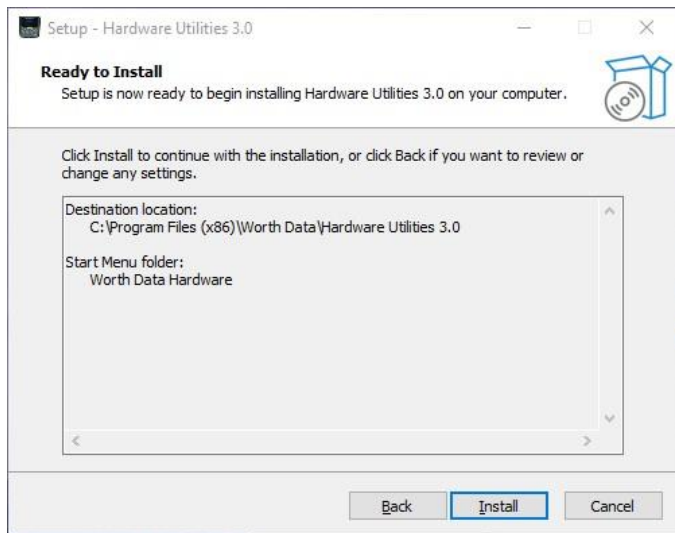

During the installation, you will see also see a dialog for installing the USB drivers. You will not see this message if you have already installed the latest drivers. Click on Install to continue.

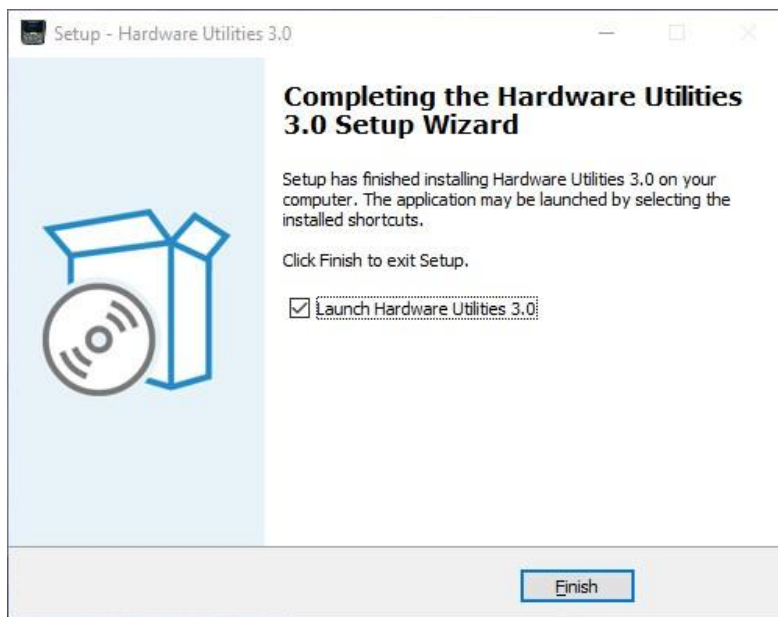
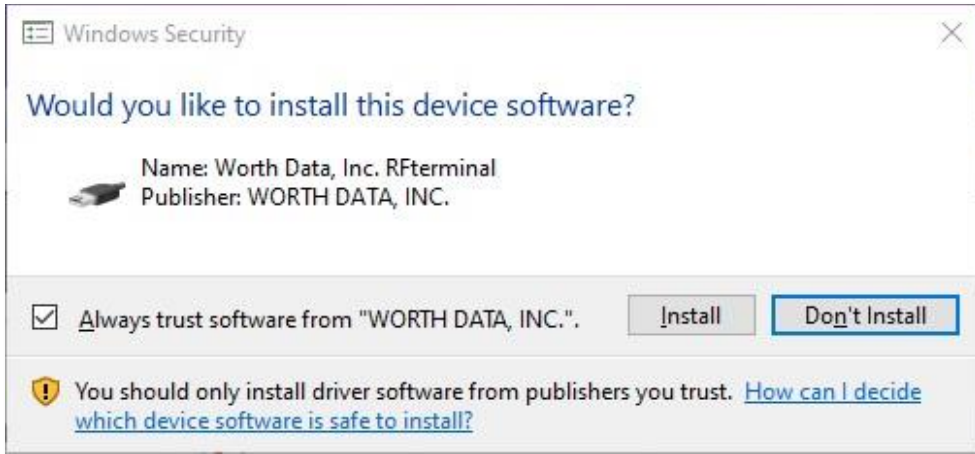

Once it completes the installation you should then Click on the "Finish" button, and it will Launch the *Hardware Utilities* - at this point you can connect the Base Station and test your RF Terminal with the tools provided.

Step 5: Running Hardware Utilities 3.0

Once the *Hardware Utilities 3.0* has completed installation you should find a program called “Hardware Utilities” in the startup menu inside the “Worth Data” Folder.

Go ahead and start Hardware Utilities 3.0. A window similar to the one shown below should open.

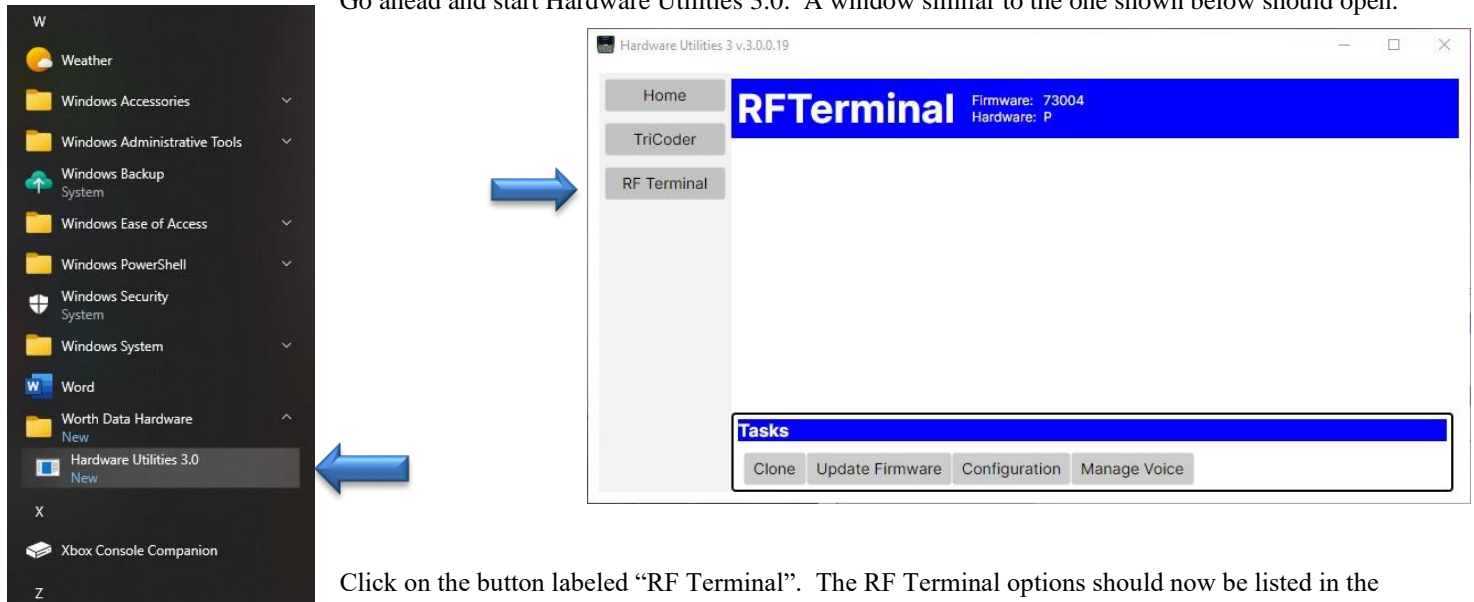

Click on the button labeled “RF Terminal”. The RF Terminal options should now be listed in the lower right pane under Tasks.

If the Base is already connected and powered up then go ahead and press the “Find Base Station and Run Test Program” button.

The program will first hunt for the Base and when found it will launch the Test Program. If the Base cannot be found refer to the Base Installation Chapter for troubleshooting tips.

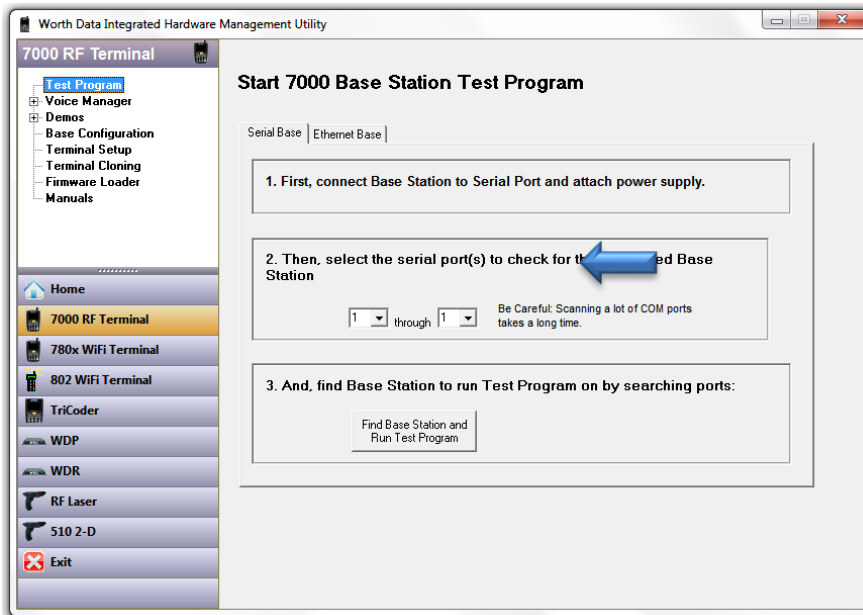

The Test Program window should look like this:

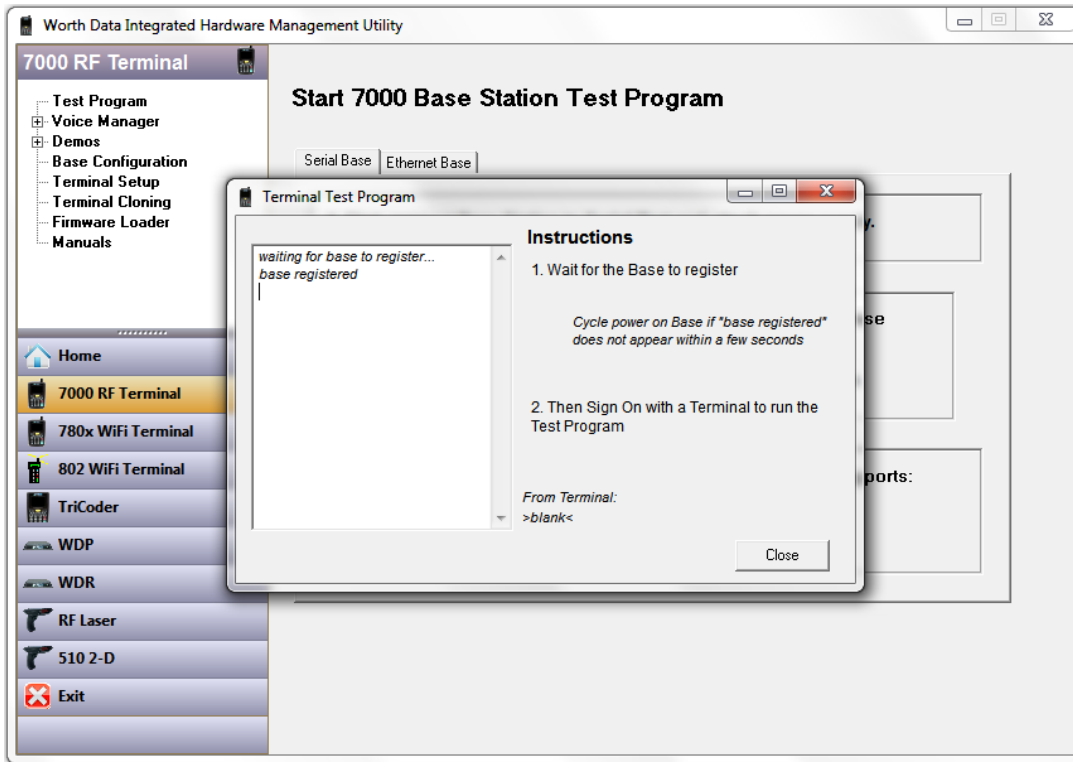

Now you can power up the RF Terminal and select option #1 to SIGN ON. The status window should show that the Base received the sign-on request along with some information about the RF Terminal and the prompt that is being sent to the RF Terminal in response to the sign-on. The prompt should now show up on the RF Terminal.

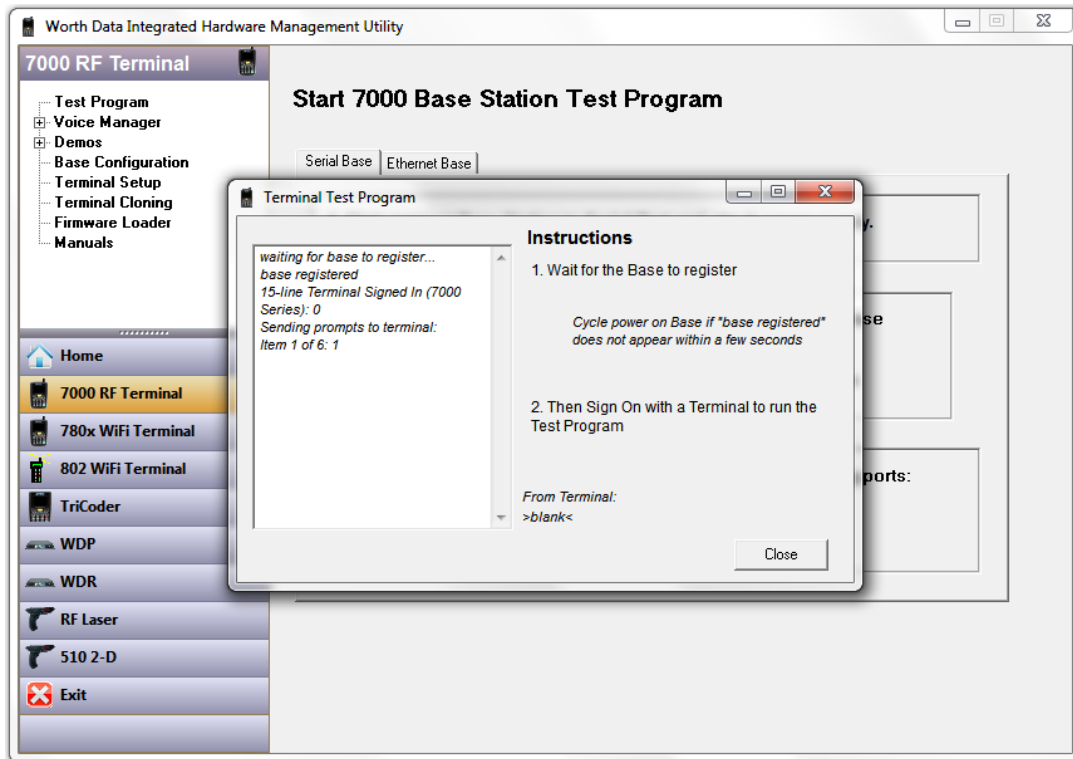

You can enter some data using the RF Terminal keypad like “555” and press enter or scan a bar code. The entered or scanned data should appear in the status window as shown below.

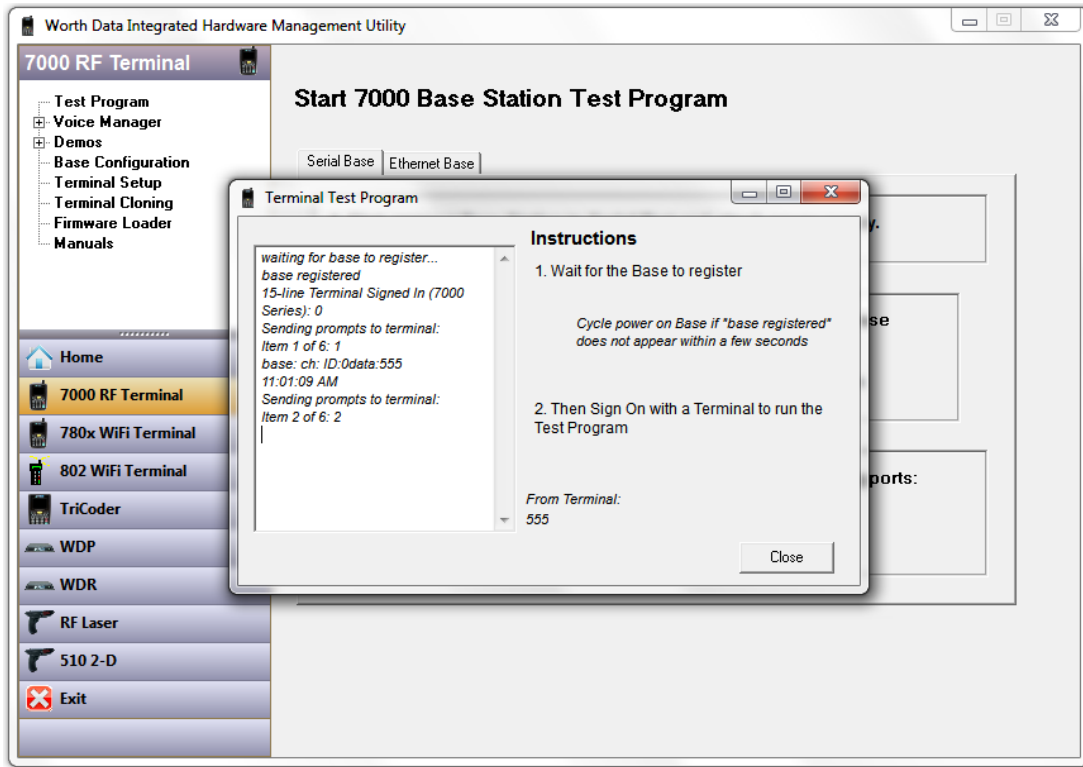

You are now up and running. You can continue to enter data or scan bar codes and observe the transactions in the status window. This demo gives you a basic idea of how the RF Terminal system works. Additional detailed information on creating your own applications can be found in the Programming section. When you are done entering data you can either press the **F1** key to sign-out or press the On/Off key to turn Off the RF Terminal. You should see the following screen when you sign out.

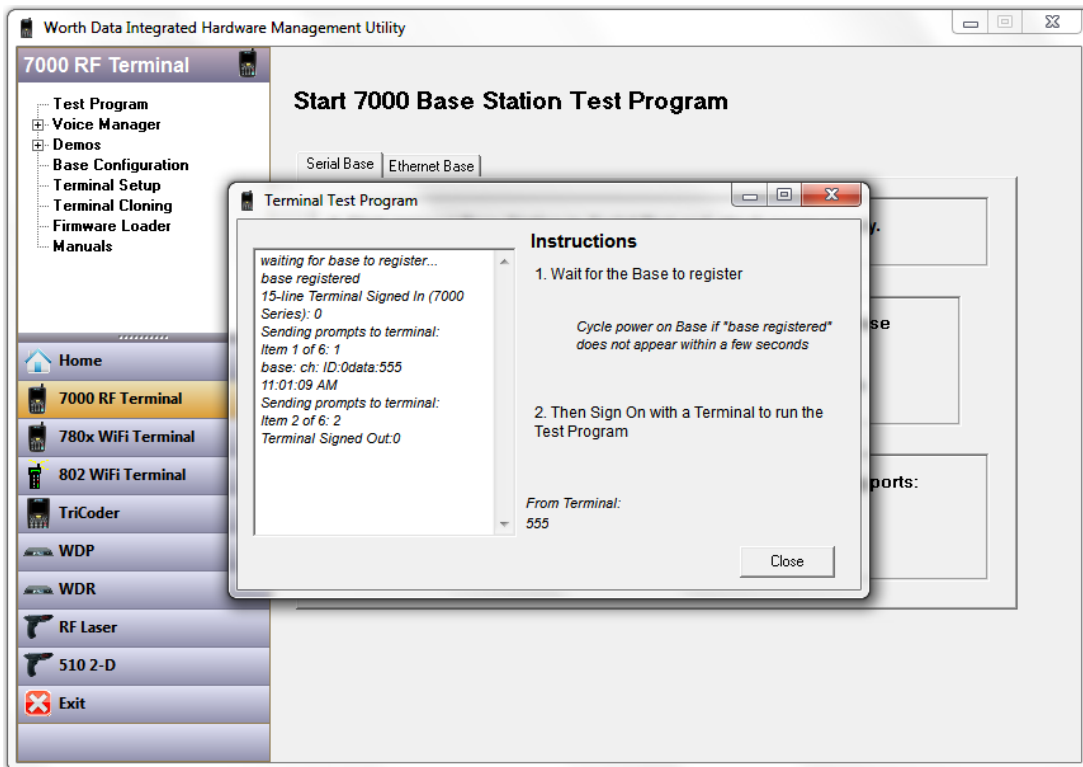

Chapter 1: *Installation*

Components

The components in your RF Terminal system will vary according to the configuration of your system. Your RF Terminal shipment should contain at least:

- An RF Terminal **LT7150H** or **LT7250H**.
- **C26 Type C USB Cable** – for charging, programming, and voice prompt upload.
- **F17 USB Power Supply** – battery charger for use with the C26 USB cable.

If *Base Stations* were ordered with your system, you should receive at least:

- A **Base Station** – **B5011**, **B5021V** or **B5021R**
- For **B5011**, a **USB cable (C21-2)**, or a **Serial Cable (F36 or F34)**
- An **Optional Power Supply** – Needed for use with the F36 or F34 Serial Cables and non PoE Ethernet - *No Power Supply is needed for most USB installations (with a full power USB Port)*, or for PoE Ethernet connections.
- A **Relay Test Cable** if ordering bases as *Relay Stations*.

Installation Sequence

1. **Start with one Terminal and Base Station.** Get everything working with the single terminal and base and then add other terminals, being certain that all terminals have unique **Terminal IDs**. After all terminals are working, add the first relay. Then add remaining relays, remembering to: 1) assign **Relay IDs**, and 2) set the jumpers of each relay to **terminated** or **not terminated** properly.
2. All equipment is shipped with the default setting of **Channel 0**, **Terminal ID 0**, and **Relay ID 0**. Unless you have other Terminal/Base configurations already operating on that channel, you probably don't need to change the channel.
3. A Base and a Relay are the same product. A jumper change is all that is required to use a Base station as a Relay. See [Chapter 3](#) for details.
4. Without attaching the Base Station to the computer, and with only the power supply plugged in the base, you can perform a **Site Test** to be sure you have adequate coverage and the radios are working perfectly. (See [Chapter 5: Site Tests](#)).
5. Now connect the Base Station to the computer's USB or serial port. Be sure to turn OFF all handshaking on the COM port used; in Windows, go to Start Menu, Settings, System, Device Manager, Ports (COM and LPT).
6. Now run your application software, or if you don't have an application yet, then run the RF Terminal Test tool in the **Hardware Utilities 3.0** program to validate that everything is working. If you have problems, refer to the [Trouble Shooting Section](#).

Connecting the Base Station

How it works...

The RF Terminal transmits data to the Base station, which in turn transmits the data **to** the host serial port. The computer software reads the data coming through the serial port and processes the information accordingly. When the computer software running on the host has a task for the terminal, it transmits data **out** to the serial port, which then passes this data on to the Base station. The Base station then broadcasts the message to the terminal, causing the terminal to display the message to the user.

The radio in the B5021 is the same as the B5011, except the relay port on the B5011 has been replaced with an Ethernet port. Therefore, the B5021V does not support operation as a relay – for Ethernet relay setups you will need a B5021R Base Station and a B5021R Ethernet Relay. On all B5021V and B5021R units the Ethernet port supports Power-over-Ethernet (PoE) standard 802.3af which allows you to run a single cable to the B5021 for more flexible installation options. An optional 802.3af compliant power injector is required to supply power over the Ethernet cable to the B5021. The Ethernet port on the B5021 supports 10/100 Mbps operation.

Connecting the Base station (B5011 & B5011R) to an RS-232 Serial Port...

If you specified a 9-pin cable (part #F36) or a 25-pin cable (part #F34) when you ordered your Base station, simply plug the RJ45 end of that cable into the **COMPUTER** port on the Base station, and the 25 or 9 pin end into your computer's serial port. If you are *not* connecting to a PC, see **Appendix C** for cable and serial pin-outs.

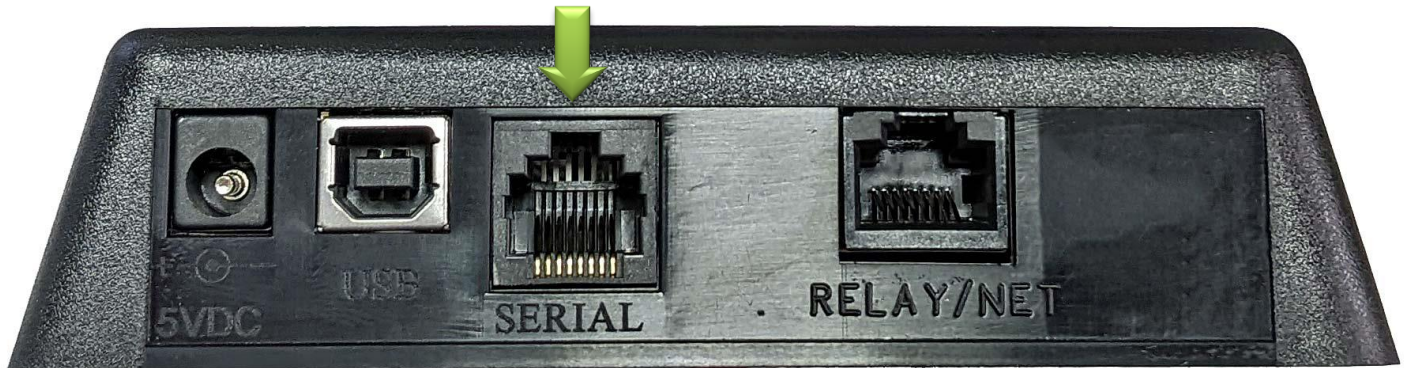

If you are using an extension cable and are having problems, test the cable by:

1. Connecting the Base station *without* using the extension cable. Simply plug in the F36 or F34 cable that came with the Base.
2. If the Base works with *only* the F36 or F34 cable in place, add in the extension cable **without changing the physical location of the Base station**. If the extension cable appears to be the culprit, check to be sure that Transmit lines are connected to the Receive lines.

Connecting the Base station (B5011 & B5021R) to a USB Port...

The B5011 and B5021R uses a standard USB type B receptacle and requires a USB A-B cable to connect it to the host computer or hub. The B5011 & B5021R can be connected directly to the host computer with a USB cable, or to a self-powered hub (hubs that have their own power supply).

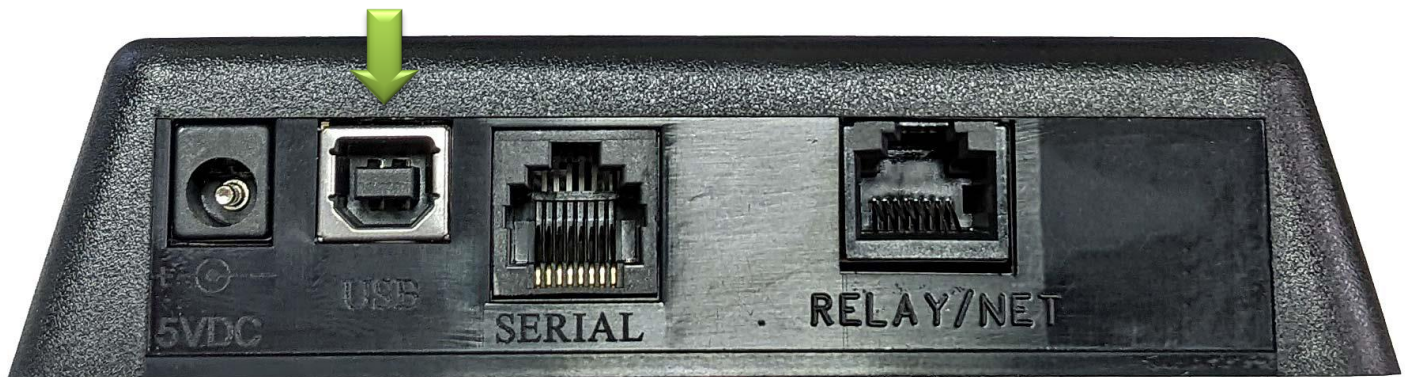

You need to connect to a full power USB port (0.5A) typically these are the motherboard connectors on a desktop computer. You will need a power supply if you are connected to a low power USB. Many laptops, all-in-one computers, and some of the newer micro form factor computers may only have low power USB ports. A powered USB hub will also work in those situations.

When connected for the first time you will need to install the USB virtual com port driver. If the driver is not found automatically it can be downloaded from the Worth Data website (<https://www.barcodehq.com/downloads.html>). Drivers are available for most versions of Windows including 11, 10, 8, 7, Vista and XP plus Linux and Mac OS X.

Once the driver is loaded a virtual com port (VCP) is created. The host program will use this COM port to communicate with the Base.

Settings for the USB COM port can be changed in the Windows “Device Manager”.

Windows will assign a COM Port to the device – As shown to the RIGHT the COM Port in this case is set as **COM6** – your system may be different.

You can change this by alt-clicking on the USB Serial Port (COMx) and selecting Properties, Then Click on the “Port Settings” Tab as shown below.

Then click on the “Advanced...” button which will pull up the “Advanced Settings for COMx” screen as shown below.

You shouldn’t need to change any other settings at this point.

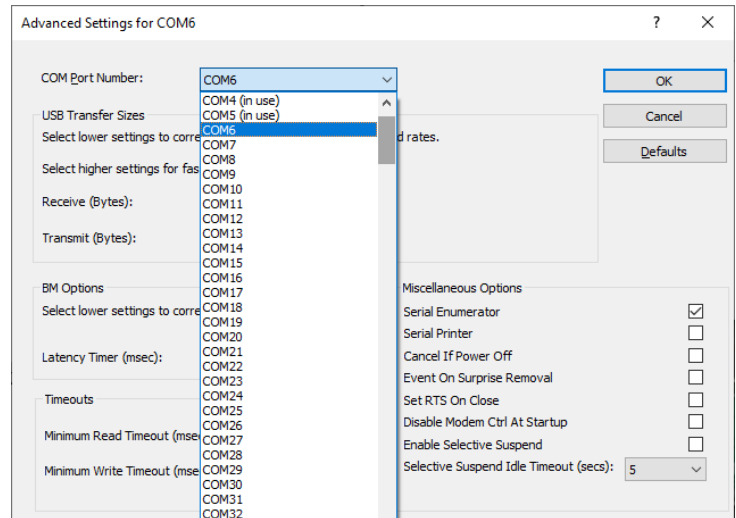
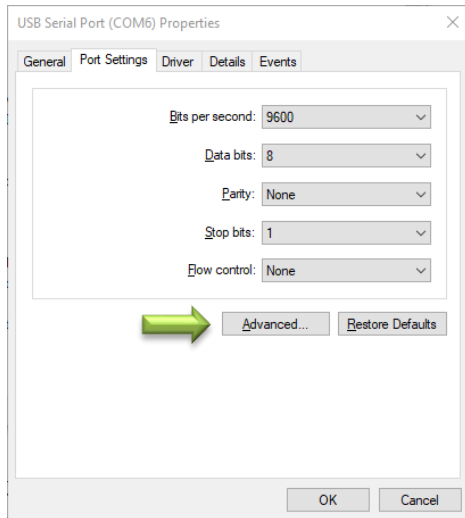
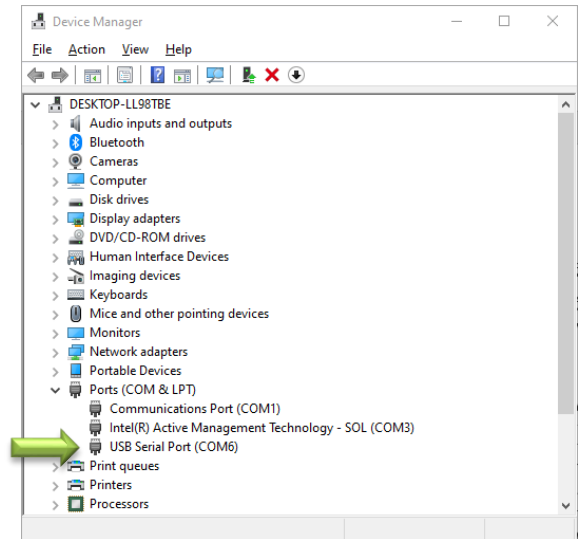

If you are still not getting the base to connect to your software application, you may need to change the JP9 jumper to configure the B5011 to use USB instead of the RS-232 Serial port. Both parts cannot be used at the same time.

JP9 selects the port to be used to connect to the host computer. It is located near the USB port on the PCB.

With the Jumper to the RIGHT (as shown) it is jumpered for USB.

With the Jumper to the LEFT, it would be jumpered for SERIAL.

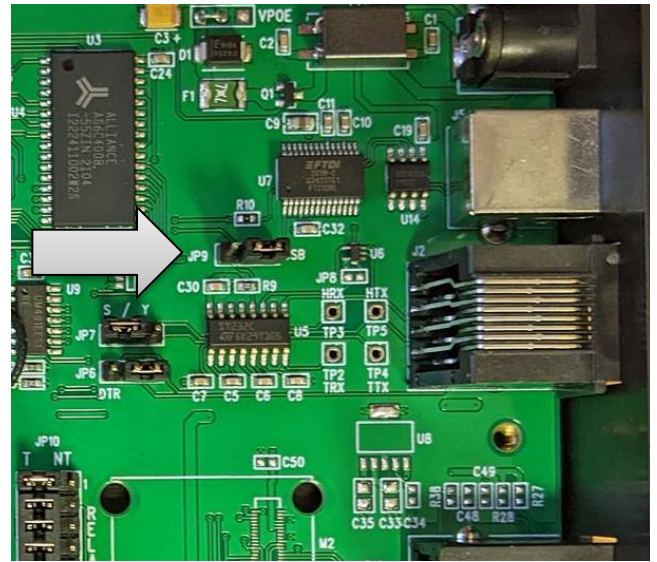

Configuring the Base station's serial settings...

After connecting the Base station to your serial port, or by USB, you may need to configure the serial settings on the Base station to match those required by your software. The default settings are:

- 9600 baud
- No parity
- 8 data bits
- 1 stop bit
- “None” protocol setting

You may want to increase the baud rate for performance. If you want to change any or all of these settings, see [Chapter 3](#) for details on configuring the Base station using the **Hardware Utilities 3.0**.

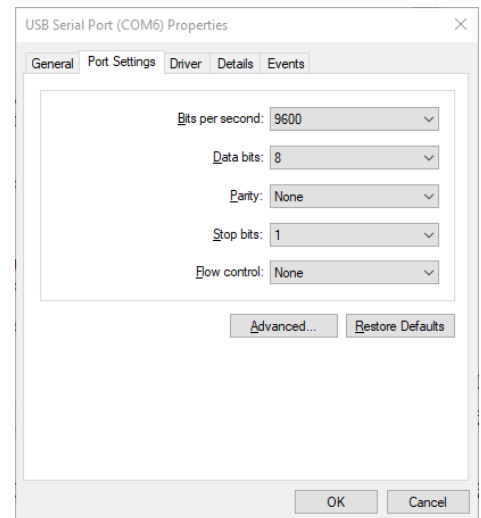

Connecting the Base station (B5021V) to Ethernet...



The B5021V Base Station has a standard 10/100 Ethernet port with 802.3af Power-over-Ethernet (PoE). If you wish to use the PoE feature, set JP11 (located near the power jack) to the VPOE position. A virtual COM port (VCP) program is available that will generate a VCP on your PC so that the B5021 Base Station will look just like it was connected to your computer via a serial cable and is compatible with existing host software written to communicate with the Base by serial. This gives you the advantage to locate the B5021 in a remote location on your network and not have to run a serial cable from the Base to the host PC running the application software. You can download the VCP program along with setup instructions from the Worth Data website:

<https://www.barcodehq.com/downloads.html>























































































































































Installation

1. If you plan to power the B5021 using an 802.3af compatible power injector you must set JP11 on the B5021 to the VPOE setting. JP11 is located near the DC jack in the upper right hand corner of the PCB. If you are using the supplied 5V power supply then no change is required.
2. Power up the B5021 then connect a CAT5 cable between the RELAY/NET port of the B5021 and a hub or switch that is on the same network as the computer to be used to configure the B5021 for the first time. The green LED on the B5021 Ethernet jack should turn on to indicate that the Ethernet port is active. The yellow LED will blink to show Ethernet activity.
3. The next step is to configure the B5021's Ethernet port for either DHCP or static IP address operation. The default setting is DHCP. You can skip the next step if you wish to use DHCP to set the IP address of the B5021.
4. The "DeviceInstaller" program is used to configure the Ethernet port on the B5021 and can be downloaded from the Worth Data website. After installation the DeviceInstaller program will be located in the Lantronix folder of the Start Menu. Next run DeviceInstaller and you should see "xPico" automatically appear in the right hand window with its IP address and MAC address. If not, verify that the B5021 is powered up and connected to the same network as the host computer running DeviceInstaller. The green LED should be solid ON and the yellow LED should be blinking.
5. Single click on "xPico" in the right window then "Assign IP" from the top menu bar. The "Assign IP Address" window should open. Select "Assign a specific IP address" if you want to use a fixed IP address for the B5021. The next screen will prompt you for the static IP address you wish to use, the subnet mask and gateway of your network. This information is available from your IT department. Once the IP address is configured you can close the "DeviceInstaller" program.
6. A com port redirector (CPR) program is used to map a virtual com port to the B5021. This will allow you to use any existing B5001 program with the B5021 by simply setting the com port of the host application to match the virtual com port set by the "CPR Manager" program. The CPR Manager program should be installed on the computer that is running the host program. Once installed, the host program will be able to communicate with the B5021 anywhere on the network. The CPR Manager program can be downloaded from the Worth Data website. After installation the CPR Manager program will be located in the Lantronix folder of the Start Menu.
7. After running DeviceInstaller to configure the IP address of the B5021, run CPR Manager to configure the virtual COM port to be assigned to the B5021. Click "Search for Devices" to find the attached B5021 which should then be listed at the bottom pane under "Device List". Next click "Add/Remove" to select the virtual COM port to assign to the B5021. Put a "check" in the box for the desired COM port then click "OK" to close the window. The selected COM port should now be listed in red in the left "Com Ports" pane and also in the "Com Port List" pane.
8. Click on the new COM port in the left pane. The "Settings" pane should open on the right. The text will be in red since the settings have not yet been saved. If the "Service" & "Host" table is empty, click on the IP Address of the B5021 in the Device List in the bottom pane to add the B5021's IP Address to this COM port. Lastly click "Save" from the top menu bar to save the settings. The text should turn from red to black and a virtual COM port should be created with these settings. You can verify the creation of the virtual COM port by checking the Ports listed in Device Manager. The B5021 port will be listed as a "Lantronix CPR Port".
9. Since CPR Manager loads a VCP driver you will not need to run CPR Manager again unless you wish to change or remove the virtual COM ports on this computer.
10. If you wish to remove the virtual COM port from this computer click "Add/Remove" then uncheck the virtual COM port assigned to the B5021. Click "OK" to close the window then "Save" to remove the port from this computer.

Base station RF Channel

To determine what channel your Base station is set to, plug in the power supply and watch the LED light on the front of the Base station. When powered up the LED will blink “the channel + 3” times  OFF  OFF  SOLID – When set as a Base Station, **Green** is the standard RF Channel – Green/Red are new Alternate RF Channels A-F, and **Orange** means it is jumpered as a Relay Station. Count the number of blinks to determine the Channel.

For example, the default channel is 0. On power up, the LED on a Base station set to channel 0 would blink 3 times green. A Base station set to channel 5 would blink 8 times green. The chart below shows the LED variations.

RF CHANNEL	JUMPERD FOR BASE STATION	JUMPERED FOR RELAY
0	 OFF  OFF  SOLID	 OFF  OFF  SOLID
1	 OFF  OFF  OFF  SOLID	 OFF  OFF  OFF  SOLID
2	 OFF  OFF  OFF  OFF  SOLID	 OFF  OFF  OFF  OFF  SOLID
3	 OFF  OFF  OFF  OFF  OFF  SOLID	 OFF  OFF  OFF  OFF  OFF  SOLID
4	 OFF  OFF  OFF  OFF  OFF  OFF  SOLID	 OFF  OFF  OFF  OFF  OFF  OFF  SOLID
5	 OFF  OFF  OFF  OFF  OFF  OFF  OFF  SOLID	 OFF  OFF  OFF  OFF  OFF  OFF  OFF  SOLID
ALT RF CHAN		
A	     SOLID	    SOLID
B	      SOLID	     SOLID
C	       SOLID	      SOLID
D	        SOLID	       SOLID
F	         SOLID	        SOLID
E	          SOLID	         SOLID

If this is the only Base station operating, leave the channel at 0. If you have other Base stations in the area, and need to change the channel, see [Chapter 3: Channel and Jumper Changes](#) for details on how to open the Base station and set the rotary switch inside to the desired channel.

RF Terminal Operation

Using the RF Terminal keypad...



The RF Terminal is turned on by pressing the green ON/OFF button located in the upper left-hand corner of the RF Terminal keypad.

It is a good idea to fully charge the RF Terminal before you use it the first time to make sure the battery charged. See below for more information on battery charging.

The RF Terminal has a *Shut Down Time* feature that allows you to determine the length of time the RF Terminal must be inactive before automatically shutting down to conserve battery power. When the RF Terminal shuts down, simply press the ON/OFF button to resume operation.

The keypad is custom designed for the RF Terminal operations. It has numeric and control keys in the non-shifted state, and alpha characters in its shifted state. You can readily determine if the SHIFT is on by the cursor on the display. When SHIFT is on, the cursor is a large rectangle. When SHIFT is off, the cursor is a narrow underline character. For all prompts which ask for a YES or NO response, the ENTER key, is the YES reply, and the 0 (zero) key is the NO reply. As you key data, you will see each character displayed on the screen. If you make a mistake, you can delete the last character by pressing the DELETE key, or you can clear all characters displayed on the screen by pressing the CLEAR key.

Battery Life Indicator

The RF Terminal detects low battery and displays the following message:

LOW BATTERY
Charge Battery
Hit Any Key_

At this point you have approximately 10% of battery life remaining. You should complete what you are doing and charge the battery soon. When the battery is too low to operate the unit properly another message is displayed:

Battery too Low to Operate
Hit Any Key to Power Down

If you turn it back on without charging batteries, you may experience constant beeping, intermittent scanning, and very irritating symptoms that look like equipment failure.

The RF Terminal also has a battery life indicator that can be accessed while operating in ONE-WAY or TWO-WAY mode or while at the Main MENU. To display the remaining battery life of the battery (as well as the date and time) press the **STATUS** key:



```
mm/dd/yy hh:mm:ss  
BATTERY: |||  zz% (zz=percent in numbers i.e. 99, 10, 05)  
R7U300X ID=0 CH=0 RL=N  
SC=N HW=P C=N Z=1
```

Press the **STATUS** key again to resume processing.

The lifetime of the RF Terminal's Li-Ion battery is 500-1000 charge cycles. If the battery runtime seems to be significantly shorter than when the device was new, the battery should be replaced. The battery in the handle is custom made for Worth Data and must be ordered from us as a complete handle assembly. The LT7150 and LT7250 units use a new HXX50 Handle with a 7pin connector and a larger 5000mAh Li-Ion 21700 battery with a custom harness.

Your old battery should be recycled. You can get free recycling information at: <https://www.rbrc.org/>

To change the HXX50 handle with battery:

1. Turn **OFF** the RF Terminal.
2. Remove the existing HXX50 Handle on the bottom of the RF Terminal by removing the two screws holding the handle in place.
3. Disconnect the connector inside the unit to remove the old handle.
4. Plug in the new HXX50 handle via the 7-pin connector.
5. Insert the handle & tighten the 2 screws.
6. Turn the reader on using the ON/OFF switch.
7. Sign ON and resume your application.



Recharging the RF Terminal Battery:

1. With the RF Terminal shut off, plug the F17 power adapter into a wall outlet, and plug into the RF Terminal using the supplied C26 USB C cable. There are 2 USB ports on the RF Terminal – you can choose either port, they are redundant for longer life in the event that one port is damaged.
2. The RF Terminal will turn On and display the following message:



**Charging Battery
Please Wait.....**

3. When the battery is fully charged, after 4-5 hours, the following message is displayed:



Battery Charge Complete

4. The unit will remain ON for a half hour or so after the charge cycle has completed and then turn OFF.
5. If you press the POWER key while the unit is charging, nothing will happen.
6. If you press the POWER key after the unit has turned OFF after completing a charge cycle and the charger is still attached, the “Charging Battery” message will display again and a charge cycle will begin.
7. It will take about 4-5 hours to fully charge a unit with the new 5000mAh HXX50 Handle battery.
8. Do not charge the battery if the Terminal is very hot or very cold since this will give a false reading on the condition of the battery and it may not get charged properly.
9. You cannot operate the unit when the charger is attached, except to charge the battery.

RF Terminal Menu Functions

Upon power-up, the RF Terminal displays the following opening screen:

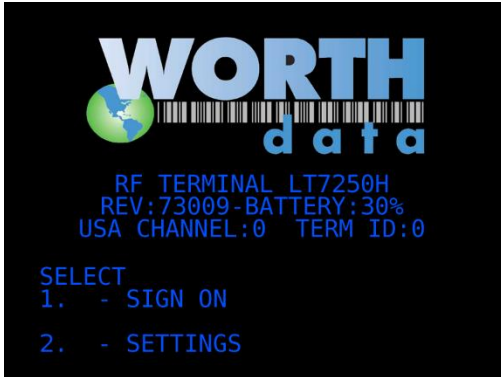

(The opening screen can be bypassed upon power up. See [Chapter 2](#))

On second line on the screen, REV: 73XXX, gives the firmware revision number.

- USA CHANNEL: 0 refers to a Terminal set to RF channel 0. You can use 0-5, and A-F for the RF Channel
- TERM ID: 0 refers to the current Terminal ID. The default setting is 0. **Every Terminal must have a unique ID.**
- Press the 1 key to SIGN ON to a host computer program through the Base station.
Note: This text prompt is now customizable in the Settings Menus
- Pressing 2 enters the Settings Menu for the RF Terminal.

You can back-out of any mode or prompt by pressing the **F1** key. For example, if you select SETTINGS but really want to SIGN IN to you software, press the **F1** key to take you back to the menu.

The **F1** key on the RF Terminal keypad works like the ESC key on the PC – it will usually get you out and back to the previous step. You can use the **F1** key to exit and SIGN OUT when signed into and using the application program (running on the host computer).

The entire mode menu can be skipped (see [Chapter 2; RF Terminal Setup](#)), causing the RF Terminal to automatically SIGN-ON.

Installing the Hardware Utilities 3.0 Software

The RF Terminal system works with the Hardware Utilities 3.0 that can be downloaded from our website at <https://www.bar-codehq.com/downloads.html>. The following tools and programs are available.

Hardware Utilities 3.0

- *Voice Manager*
- *Base Configuration*
- *Terminal Configuration*
- *Firmware Loader*
- *Test Program*
- *Cloning*

Running the Test Program...

The test program is provided to help you test your RF Terminal with a two-way communication program. Simply connect the B50xx base station to the host computer and start the program. It will search for the Base and start the demo.

Chapter 2: RF Terminal Setup

The RF Terminal can be configured using the Terminal Setup Menu. Most users do not need to change anything in the setup. The most commonly changed setup parameters are the *Terminal ID* (especially if you have more than 1 terminal) and the *Channel* (if you are adding an additional Base station).

Factory Default 1D RF Terminal Configuration

Parameter	Default Setting	Parameter	Default Setting		
RF Configuration	RF Channel - 0	MSI /Plessey Code	MSI - OFF		
	Terminal ID - 0		MSI with 1 mod 10 - OFF		
	Security code - OFF		MSI with 2 mod 10 - OFF		
	Skip opening screen - OFF		MSI with mod 11/mod 10 - OFF		
	Control Keys Only - OFF		Transmit check digit - 0		
	Auto Check Back - 00		Plessey - OFF		
	Relay Existence - NO		Codabar	Codabar - OFF	
	Beep In Auto Check -YES			CLSI format - OFF	
	Shutdown In Auto Check -NO			START STOP Char - OFF	
				Code 128 - ON	
	Code 3 of 9	Code 128 - ON			
	Code 39 - ON	UCC/EAN-128 - OFF			
	Full ASCII - ON	Databar / RSS-14		Databar / RSS-14 - OFF	
	Accumulate Mode - ON				
	Transmit Start Stop - OFF				
	MOD 43 Check Digit - OFF				
	Transmit MOD 43 - OFF				
	Caps lock - OFF				
	Decode Option - 0				
2 of 5 Code	Interleaved 2 of 5 - OFF	Code 93 / Code 11	Code 93 - OFF		
	Check Digit - OFF		Code 93 full ASCII - ON		
	Transmit Check Digit - OFF		Code 11 - OFF		
	Standard 2 of 5 - OFF		Code 11 Check Trans - 0		
	2 of 5 Length - 06				
UPC-A EAN 13	UPC/EAN ALL - ON	BT Settings	BT Printer Setup		
	Supplements - OFF		Reset BT->Default		
	UPC-A NSC - ON		Pair if Already Prd		
			BT Printer Test		
UPC-E EAN 8	UPC-A check digit transmitted - ON			BT PIN Code - XXXX	
	EAN-13 country code transmitted - ON		Time & Date Settings	Date Format - USA	
	EAN-13 Check - ON			Year Output - 2 digits	
	ISBN EAN-13 mode - OFF			Shut Down Time - 5 min	
	UPC-A as EAN-13 - OFF			Speaker Options	Beep Volume - medium
	UPC-E First Char - OFF				Beep Tone - 2
	EAN-8 First Char - ON	Voice Volume - medium			
	UPC-E Check Digit - OFF	Keypad Tone - ON			
	EAN-8 Check Digit - ON	Laser Options	Double Decode - OFF		
	UPC-E Expanded Transmission - OFF		4.5 Second Beam - OFF		
UPC-E1 - OFF					
Other Bar Code Options	Storage Tek Label - OFF		LCD Settings	4/6 Line Legacy Mode -OFF	
	LabelCode 5 - OFF			Background Color - 1 (black)	
	LabelCode 4 - OFF	Text Color - 2 (blue)			
	Barcode IDs - OFF	Brightness - medium			
		Brightness Timeout - 5 sec			

Factory Default 2D RF Terminal Configuration (In addition to 1D above)

PDF 417 - ON	Aztec Code - ON
Micro PDF 417 - ON	Aztec Runes - OFF
Codablock F - OFF	QR Code - ON
Data Matrix ECC-140 - OFF	Micro QR - ON
Data Matrix ECC-200 - ON	Maxi Code - ON
(1D) POSTNET - OFF	(1D) INTELLIGENT MAIL - OFF
NEGATIVE BARCODE - OFF	

Using the SETTINGS Menu on the RF Terminal

The RF Terminal can be setup via the Terminals' keypad by entering *SETTINGS Mode* from the main menu.

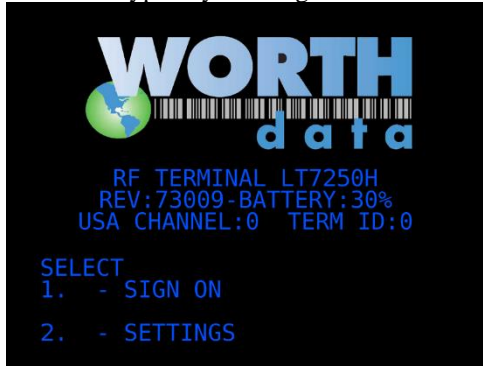

Press the **2** key. The next menu allows you to choose which item to configure:

RF TERMINAL SETUP

RF CONFIGURATION ----- **1**

CODE OPTIONS ----- **2**

DATE & TIME SETTINGS ----- **3**

SPEAKER SETTINGS ----- **4**

LCD SETTINGS ----- **5**

OTHER SETTINGS ----- **6**

SYSTEM TOOLS ----- **7**

BT SETTINGS ----- **8**

CUSTOM SIGN ON ----- **9**

DONE/EXIT ----- **0**

Select the option you want to set or verify or press 0 or the F1 key to exit back to the **MAIN MENU**.

The groups in the Settings Menu contain the following setup parameters:

Setup Group	Parameter	Setup Group	Parameter
RF Configuration 1	RF Channel	LCD 5	4 Line Legacy Mode
	Terminal ID		6 Line Legacy Mode
	Security Code		Background Color
	Skip Opening Screen		Text Color
	Control Keys Only		Brightness
	Auto Check Back		Brightness Timeout
	Relay Existence	Other 6	Preamble
	Beep In Auto Check		Postamble
	Shutdown In Auto Chk		Characters
Bar Codes 2	Code 3 of 9	System Tools 7	Encryption Key
	UPC-A, EAN 13		Play Voice Prompt
	UPC-E, EAN 8		Reset To Factory Default
	Code 128		Language
	2 of 5 Codes		Host Interface
	Codabar		Wait For Prompt Message
	MSI/ Plessey		Password For Setup
	Code 93 / Code 11		Site Test - Single
DataBar / RSS / Others	Site Test - Continuous		
Date/Time 3	Time	BT Setup 8	One Way Mode
	Date		BT Printer Setup
	Date Format		Reset BT -> Default
	Year Output		Pair if already Paired YES
	Shut Down Time		BT Printer Test
Speaker 4	Beep Volume	Custom Sign On 9	BT PIN Code xxxx
	Beep Tone		Line 1 Text:
	Voice Volume		Line 2 Text:
	Keypad Tone		

The LT7150H & LT7250 H have a BT compatible radio for talking to compatible portable printers:

Once you have selected a group to edit, you will see each parameter displayed in the order listed above. Use the next section of this chapter as a reference for all RF Terminal Setup Parameters.



RF Configuration

Default settings are shown in **bold** type.

The RF Terminal will typically require no setup changes except, Terminal ID (if using more than one terminal) and enabling bar codes to be read other than UPC or Code 39.

RF Terminal ID

Default ID	0
Available IDs	0-9, A-Z, a-z, - =

- Every terminal needs a unique **Terminal ID**. The default **Terminal ID** is always shipped as **0**. If you have more than one RF Terminal assigned to a Base Station, you must be sure that each RF Terminal has a unique **Terminal ID**, (otherwise you will have big troubles including false error messages). The **Terminal ID** is always displayed on the Start Up screen when you power up the terminal. There are 64 **Terminal IDs** available - **0-9, A-Z, a-z**, and the special characters "-" and "=" . To change the **Terminal ID**, select option 2 on the keypad after which a box will appear where you can enter the desired **Terminal ID**. Enter one character for the **Terminal ID**.
- Press <SHIFT>  to get Upper Case Alpha ID's, Press <SHIFT><F2> -  **F2** to get lowercase ID's

RF Terminal Channel

Default Channel	0
Available Channels	0-5, A-F*

- The terminal's radio operates by "frequency hopping" spread spectrum. The radios hop from one frequency to another using a pseudo-random sequence. The radio goes through 26 different frequencies and then repeats the sequence – all in the 902-928 MHz band at 250 milliwatts of power. Different sequences define the channels. It is possible to have more than one RF Network in the same area, providing each RF Network is on separate channels to avoid interference and general confusion.
- The default Channel is always shipped as 0. There are 6 standard channels in the USA 0-5. The Channel can be set by pressing the 1 key when in the RF Configuration menu. Each time you press the 1 key the Channel will increment through the 6 possible standard channels
- We also now have 6 new Alternate RF Channels with that *can offer more RF range* at the very far edge of the RF range – these are RF channels A-F. The Channel can be set by pressing the 1 key when in the RF Configuration menu. Each time you press the 1 key the Channel will increment through the 6 possible standard channels, and the 6 Alternate channels (if you have the latest hardware and firmware loaded).

All Terminals, Base Stations and Relays in the RF Network must be set to the same channel. The channel is always displayed on the Start Up screen when you power up the Terminal. It is possible to have more than one RF Network in the same area, providing each RF Network is on separate channels to avoid interference and general confusion. *Note: only newer 7100 units and B5011 units, manufactured in 2022 and later, can operate with the newer RF Channels A-F. These new channels run at a different internal throughput speed that can provide improved RF range if you need additional RF range beyond what channels 0-5 provide. If you don't see these channels in the SETUP then you don't have the latest hardware, or firmware installed to support this mode. You will also need the latest B5011 Base Station and Firmware to support this mode.

Security Code

Security Code	OFF
Available security codes	3 characters

- A Security Code can be utilized to minimize the possibility of a Base Station listening to data from a Terminal that is talking to a different Base Station. A Security Code can also prevent interference from having many Base Station/RF Terminal configurations in one area; i.e. a merchandise mart with multiple vendors all running RF Terminal networks.
- A Security Code consists of 3 characters - any combination of ASCII 33 - ASCII 126. This allows for the possibility of more than 830,000 different character combinations. The characters are entered using the bar coded FULL ASCII MENU provided in Appendix O; ASCII Code Equivalent Table.

- Once you press 3 to enable the Security Code, you will see 3 boxes appear where you can enter the desired security code. Pressing the CLEAR key will reset the Security Code to the default value which is OFF. You can enter any key on the keypad. If you press the shift key the cursor will turn RED and you can enter any of the shifted values on the keypad.
- You must also enter a matching security code into the Base using the **Hardware Utilities** program.

To enter characters that are not on the keypad, use the FULL ASCII MENU provided in **Appendix O**.

Skip Opening Screen

Skip Opening Screen	OFF	ON		4
----------------------------	-----	----	--	---

- Many users want to skip the opening screens and go directly to TWO WAY communication once their programs are fully operational. Selecting **ON** will automatically take the operator to their program if it is running on power up and directly into your application, skipping the usual Mode Menu. If you want to return to the Mode Menu at any time, simply press F1.

Control Keys Only

Control Keys Only	OFF	ON		5
--------------------------	-----	----	--	---

- Several special keys on the RF Terminal keypad can generate a response automatically, sending a separate message to the host by simply pressing the appropriate control key (without pressing the ENTER key afterward). This allows for simple and fast scrolling by the operator. The arrow keys, Begin, End, and Search are the specific keys supported. The default setting is to require the ENTER key to be pressed before data transmission.
- If you set this feature to ON, in order for the RF Terminal to transmit the following values, the corresponding Control Key must be the first key pressed in a data entry sequence. If it is not the first data entered, the arrow key is ignored.

Control Key on RF Terminal	Code transmitted to Host
Up Arrow	FS (ASCII 28)
Down Arrow	GS (ASCII 29)
Left Arrow	RS (ASCII 30)
Right Arrow	US (ASCII 31)
Begin	ETB (ASCII 23)
End	CAN (ASCII 24)
Search	VT (ASCII 11)

The message is sent to the host as:

Bytes	Function	Value
1	RF Terminal ID	0-9, A-Z, a-z, - =
2	Data Transmitted	ASCII Value from Table Above
Last	Terminator of Message	CR

Automatic Check Back

Auto Check Back	00		6
------------------------	----	--	---

This parameter should not be changed under normal circumstances. After the host sends a prompt, the Terminal goes to sleep waiting on the operator to key or scan input in response to the prompt. It waits until the *Automatic Shut Off* time or until the operator responds. This parameter sets the time that the Terminal stops waiting on input from the operator, discards the current prompt, and goes back to the host to see if there is a change in instructions. If no change, the host must resend the prompt again because the Terminal has discarded the original prompt. The host now has the opportunity to change a prompt. The time can be set in increments of 5 seconds, up to 495 seconds. The default value is 00. The values possible for entry are 00-99. An entered 99 gives 99x5 seconds, or 495 seconds between check backs. The Terminal sends back an *ASCII 07* for the data back to the host (ID ASCII 07 CR). To change this value, press the **6** key in the **RF Configuration** menu and enter the 2 digit value desired.

Relay Existence

Relay Existence	OFF	ON	7
-----------------	-----	----	---

- If you want to use a Relay Station you must set this to ON. Press the 7 key in the **RF Configuration** menu to toggle this feature ON or OFF.

Beep In Auto Check

Beep In Auto Check	YES	NO	8
--------------------	-----	----	---

Shutdown In Auto Chk

Shutdown In Auto Chk	YES	NO	9
----------------------	-----	----	---

Show 1-Way Mode On Opening Screen

Show 1-Way Selection	NO	YES	A
----------------------	----	-----	---

- Show 1-Way Mode on Opening Screen option is set to NO by default as it is rarely used – you can turn this on by changing it to YES pressing the A key on the RF Terminal.

Bar Code Options

Bar Code Options - *LT7150H models*

Select 1 on the screen shown below to get to the **Bar Code Options** Menu.

BAR CODE SETUP
1D BAR CODE SETUP **1**

OTHER OPTIONS **3**
DONE/EXIT **0**

Code 3 of 9 (Code 39)

Code 3 of 9	ON	OFF	1
Full ASCII	ON	OFF	2
Accumulate Mode	ON	OFF	3
Transmit Start Stop	ON	OFF	4
MOD 43 Check Digit	ON	OFF	5
Transmit MOD 43	ON	OFF	6
Caps Lock	ON	OFF	7
Decode Option	0, 1, 2		8

- The Start and Stop character for Code 39 is the * character. Setting 4 determines whether or not those characters are transmitted to the computer along with the data. For example, at setting ON, the data of 1234 would be transmitted as *1234*. Transmitting the start and stop characters can be useful if you need to differentiate between data that comes from a bar code versus data coming from the keypad.
- Enabling use of the Mod 43 check character requires that the last character of your bar code conform to the Mod 43 check character specifications. Enable transmission (6) will send the check digit data along with the rest of the bar code data to your computer. To use 6, you must also be using 5.
- Caps Lock ON causes lower case letters read as data to be transmitted to the computer as UPPER CASE, and upper case letters to be transmitted as LOWER CASE. Numbers, punctuation and control characters are not affected. Caps Lock OFF means that letters will be transmitted exactly as read. This setting applies to all bar code types.
- See [Appendix A; Bar Code Scanning, Accumulate Mode](#) for more information regarding Accumulate Mode.
- Decode Option is used to allow reading of Code 39 bar codes through a windshield. Setting this option to 1 will loosen up the decoder a little and option 2 will loosen up the decoder a bit more. This should be used with caution since using a looser decoder can cause substitutions.

UPC-A / EAN-13 Options

UPC/EAN ALL	ON	OFF	1
UPC/EAN Supplements	ON	OFF	2
UPC-A NSC	ON	OFF	3
UPC-A Check	ON	OFF	4
EAN-13 First 2 Digits	ON	OFF	5
EAN-13 Check	ON	OFF	6
ISBN EAN-13 Mode	ON	OFF	7
UPC-A as EAN-13	ON	OFF	8

- Use setting 2 to enable reading of the 2 and 5 digit UPC/EAN supplements commonly found on magazines and paperback books as well as the Extended Coupon Codes. Using this setting force left to right reading of UPC codes to assure that the supplement code is not missed.

- Use setting 3 to enable transmission of the NSC character to your computer. The Number System Character is the leading character in the bar code.
- Use setting 4 to enable transmission of the check digit character to your computer. The check digit is the last character and is based upon a calculation performed on the other characters.
- Use setting 5 to enable the transmission of the EAN-13 country code (the first 2 digits).
- Use setting 6 to enable the transmission of the EAN-13 check digit.
- ISBN (International Standard Book Numbering) bar codes are EAN-13 with a 5-digit supplement. If the “Bookland” bar code uses 978 (books) or 977 (periodicals) as the first three digits, then the RF Terminal can transmit it in the ISBN format. To enable transmission of the ISBN format, set option 7 to ON. To return to the default of normal EAN-13 transmission, set option 7 to OFF.
- UPC-A can be transmitted in EAN-13 format by adding a leading 0 (USA county code) to the UPC-A data. To transmit in EAN-13 format, set option 8 to ON.

UPC-E / EAN-8 Options

UPC-E First Digit	ON	OFF	1
EAN-8 First Digit	ON	OFF	2
UPC-E Check Digit	ON	OFF	3
EAN-8 Check Digit	ON	OFF	4
UPC-E Expanded	ON	OFF	5
UPC-E1	ON	OFF	6

- Use setting 1 and 2 to enable or disable the UPC-E or EAN-8 first digit.
- Use setting 3 and 4 to enable or disable the UPC-E or EAN-8 check digit. The check digit is the last character and is based upon a calculation performed on the other characters.
- Use setting 5 to select UPC-E0 compressed or expanded. When set to ON (the default setting) UPC-E1 codes are transmitted as is, when set to OFF UPC-E1 codes are transmitted with inserted zeros to make them the same length as a UPC-A bar code. An NSC of 0 is assumed.
- Use setting 6 to enable the reading of UPC-E1 bar codes. Do not enable UPC-E1 if you plan on reading EAN-13 bar codes. You may experience partial reads when reading EAN-13.
- If you prefer to transmit UPC-E bar codes in a 6-digit format while EAN-8 is transmitted in its original 8-digit format, set option 7 to ON.

Code 128

Code 128	ON	OFF	1
UCC/EAN 128	ON	OFF	2

- GS1-128 UCC-128/EAN-128 Code is a subset of Code 128 adopted by the GS1 (UCC and EAN) council’s product, container, and shipping label symbology. GS1-128 UCC/EAN-128 bar codes always start with a Function Code 1 character. In addition, a Function Code 1 character terminates all variable length fields unless they are the last field in the bar code. The RF Terminal outputs the following for the special function codes and start sequences:
 -]C1 Start C/Function Code 1
 - ^] (GS) Function Code 1 as a variable string terminator
- If UCC/EAN 128 is enabled, the reader looks for the Function Code 1 as the leading character, and treats all such codes as UCC/EAN 128 bar codes.

Codabar

Codabar	ON	OFF	1
----------------	----	-----	----------

Codabar CLSI	ON	OFF	2
Start Stop Character	ON	OFF	3

- CLSI is a form of Codabar often used by libraries.
- Setting 3 will transmit the Codabar start and stop characters with the bar code data to your computer. If you are varying the start and stop characters to differentiate between different labels, transmitting the start and stop can be helpful.

2 of 5 Code

Interleaved 2 of 5	ON	OFF	1
Check Digit	ON	OFF	2
Transmit Check Digit	ON	OFF	3
Standard 2 of 5	ON	OFF	4
2 of 5 Code Length		06	5

- Setting **2** requires that the last digit in your bar code conform to the specifications for the 2 of 5 check digit calculation.
- Transmission of the check digit (**3**) requires the use of setting **2** and will transmit the check digit along with the bar code data to the computer.
- 2 of 5 is so susceptible to misreads that the RF Terminal adds an additional safeguard - it can be configured to look for fixed-length data only.
- The default setting of **06** causes the RF Terminal to read **only** 2 of 5 codes that are 6 digits in length. To set the RF Terminal to read a different length, enter any two-digit number. 2 of 5 code must always be an even number of digits so the length setting must always be an even number. GTIN-14 bar codes would need the length of 14, as they are most common Interleaved 2 of 5
- Reading variable length I 2of5 or 2 of 5 codes is to be avoided if at all possible. The **00** setting is supplied for the purposes of reading codes of unknown length, counting the digits and setting the length to the proper number. Leaving it set to 00 will create the likelihood of misreads on many bar codes.

MSI and Plessey

MSI/Plessey	ON	OFF	1
MSI/Plessey-Single Mod 10 Check Digit	ON	OFF	1
MSI/Plessey-Double Mod 10 Check Digit	ON	OFF	1
MSI/Plessey-Single Mod 11/Single Mod 10 Check	ON	OFF	1
Enable Plessey / Disable MSI	ON	OFF	1
Transmit Check Digits	0, 1 or 2		2

- The MSI/Plessey options are selected by pressing the **1** key to select the desired mode of operation.
- If you have enabled the Mod 10 or Mod 11 check digits, they will be transmitted along with your bar code data from the RF Terminal to your host.

Code 93 / Code 11

Code 93	ON	OFF	1
Code 93 Full ASCII	ON	OFF	2
Code 11	ON	OFF	3
Code 11 Check Digit Transmission	0, 1 or 2		4

- Code 93 is similar in character set to Code 39. Code 93 is not a commonly used bar code symbology.

DataBar / RSS-14 / Others

DataBar / RSS-14	ON	OFF	1
DataBar / RSS-14 plus Identifiers	ON	OFF	1
DataBar / RSS-14 plus UCC-128 Format	ON	OFF	1

By default, DataBar / RSS-14 is disabled. Press the **1** key to toggle through the DataBar / RSS-14 options listed above. We support the standard and stacked version of GS1 DataBar / RSS-14. For more information on GS1 DataBar, see the GS1.org website at

<https://www.gs1.org/productssolutions/barcodes/databar/>

Other Bar Code Options

Storage Tek Label	ON	OFF	2
LabelCode 5	ON	OFF	3
LabelCode 4	ON	OFF	4
Bar Code IDs	ON	OFF	5

The Storage Tek Tape Label code is a proprietary variation of Code 39 code used for the storage of computer data tapes. Enabling the tape label code does not disable reading of Code 128 or Code 39 bar codes.

LabelCode 5 and LabelCode 4 are proprietary bar code types used by Follet.

Bar Code ID's are characters assigned to each bar code type to identify that particular type of code. These Bar Code IDs can output as prefix to the bar code data to identify what type of bar code you are using. The Bar Code ID's are assigned as follows:

Bar Code	ID	Bar Code	ID	Bar Code	ID	Bar Code	ID
Codabar	a	2 of 5	f	UPC-E (1)	o	LabelCode 4	y
Code 39	b	Code 128	g	EAN-8	p	LabelCode 5	z
UPC-A	c	Code 93	i	RSS-14	r		
EAN-13	d	MSI	j	StorageTek	s		
I 2of 5	e	UPC-E(0)	n	Plessey	x		

The ID character is transmitted in front of the bar code data.

Scan Engine Options – LT7150H

Select 2 on the screen shown below to get to the **Bar Code Options** Menu

RF TERMINAL SETUP	
RF CONFIGURATION	1
BAR CODE OPTIONS	2
DATE & TIME SETTINGS	3
SPEAKER SETTINGS	4
LCD SETTINGS	5
OTHER SETTINGS	6
SYSTEM TOOLS	7
BT SETUP	8
DONE/EXIT	0

Select 3 on the screen shown below to get to the **Scan Engine Options** Menu

BAR CODE SETUP	
1D BAR CODE SETUP	1
SCAN ENGINE OPTIONS	3
DONE/EXIT	0

Double Decode

Double Decode	ON	OFF	1
---------------	----	-----	---

- **Double Decode** is there to minimize the possibility of misreads when scanning very poor quality bar codes. This option forces the RF Terminal to keep reading until it gets two results that are identical. This "double scan checking" takes longer but will minimize misreads since it must get the same result twice before considering it a "good" read.

4.5 Second Laser Beam

4.5 Second Laser Beam	ON	OFF	2
-----------------------	----	-----	---

- **4.5-second laser beam** increases the amount of time the laser beam is activated, giving the laser more time to try and read a code. This option is useful for trying to read poor quality code. The default beam time is 2 seconds.

Filter Mode

Filter Mode	0 – 3	4
-------------	-------	---

- If you are trying to read poorly printed bar codes, this setting may improve the performance of the decoder.
- Mode 0 is the default setting and works best with good quality bar codes.
- Mode 1 might help when reading codes printed with uneven levels of dark and light areas.
- Mode 2 might help when reading codes with poor print contrast (like a dark or colored background).
- Mode 3 might help when reading codes with holes or voids such as damaged or dot-matrix printed codes.
- When selecting mode 1 or 3 it would be a good idea to set **Double Decode** to **ON** to avoid errors.

Bar Code Options - *LT7250H models*

Select 2 on the screen shown below to get to the **Bar Code Options** Menu

RF TERMINAL SETUP	
RF CONFIGURATION	1
BAR CODE OPTIONS	2
DATE & TIME SETTINGS	3
SPEAKER SETTINGS	4
LCD SETTINGS	5
OTHER SETTINGS	6
SYSTEM TOOLS	7
BT SETUP	8
DONE/EXIT	0

Select the 1D, 2D, or OTHER OPTIONS as shown below to get into the setup for the 1D and 2D codes.

BAR CODE SETUP	
1D BAR CODE SETUP	1
2D BAR CODE SETUP	2 (not shown on LT7150H models)
OTHER OPTIONS	3
DONE/EXIT	0

1D Bar Code Setup - *LT7250H models*

Code 3 of 9			1
UPC-A EAN-13			2
UPC-E EAN-8			3
Code 128			4
2 of 5 Codes			5
Codabar			6
MSI Plessey			7
Code 93/Code11			8
DataBar/RSS/Others			9
Postnet	ON	OFF	A
Intelligent Mail	ON	OFF	B

The 1D settings for all of the 1D Bar Codes above match the 1D setup from the previous section – refer to each code type for the specific options for those codes - POSTNET and INTELLIGENT MAIL (IMBC) are at the bottom of the 1D setup menu.

2D Bar Code Setup - *LT7250H models*

PDF 417	ON	OFF	1
MicroPDF 417	ON	OFF	2
Data Matrix ECC 140	ON	OFF	3
Aztec Code	ON	OFF	4
QR Code	ON	OFF	5
Micro QR	ON	OFF	6
Maxi Code	ON	OFF	7

2D RF Terminals also have POSTNET and INTELLIGENT MAIL (IMBC) added to the 1D setup menu.

Scan Engine Options – LT7250H

Redundancy

Redundancy	1, 2, 3	1
-------------------	----------------	----------

Redundancy can be changed from 1 – standard single decode scanning mode, to 2 for double decodes, or 3 for triple decodes – this determines the number of times the scanner reads the same code before it accepts the result – this can be helpful for poorly printed or damaged codes.

LCD Scanning

LCD Scanning	ON	OFF	2
---------------------	-----------	------------	----------

LCD Scanning: The 2D RF Terminals have the ability to scan codes on a LCD, Monitor, Phone, Tablet, or CRT screen this, by default this is turned off.

Date & Time Settings

Set Time

The time is set using a 4-digit military **hhmm** format. For example, to set the time to 3:08 p.m., you would enter **1508**. To display the time during operation, press the STATUS key.

Set Date

For correct date display, the 6-digit date must be set in the date format you plan to use. By default the US terminals use the US date format of **dd/mm/yy**. If you change the date format, you must re-set the date to match the new format. For example, to set a date of January 20, 2021, you would enter 012021 (US format) or 200121 (European format). To display the date during operation, press the STATUS key.

Date Format

US Format	0
European Format	1

- The US format of **mm/dd/yy** is the default setting.
- If you switch formats, you must reset the date (SET DATE) in the new format also.

Year Output

2 digit	0
4 digit	1

- By default, the RF Terminal is configured to display and transmit the year in a **2-digit format**; i.e. 2021 would transmit and display as 21.
- *Before* you change the RF Terminal to display a 4-digit year, i.e. **2021**, make sure that the software receiving data from the RF Terminal is set up to accept a 4-digit year.

Shut Down Time

By default, if the RF Terminal is inactive (no keystrokes or scanning) for more than 5 minutes, it will shut itself down in order to conserve batteries. This includes SIGNING OFF if appropriate. To resume operation, you must turn the RF Terminal back on using the ON/OFF key. To change the amount of time the RF Terminal waits before shutting down enter two digits - the default is 05 (5 minutes)- to correspond to the length of time in minutes. For example, 01 would be 1 minute. *Setting the Shut Down Time to 00 will disable automatic shutdown.*

Speaker Settings

Beep Volume

OFF	1
Low	1
Medium	1
High	1

The default volume of the “Beep” is Medium. Each time you press the “1” key you will hear a beep at the different volume settings. When you are happy with the loudness of the beep tone, press 0 or F1 to exit.

Beep Tone

1 - Lowest	2
2 - Low	2
3 - Medium	2
4 - High	2
5 - Highest	2

The default beep tone is **3 – Medium**. Each time you press the “**2**” key you will hear a beep at various tones. When you are happy with the tone of the beep, press 0 or F1 to exit.

Voice Volume

OFF	3
Low	3
Medium	3
High	3

The default volume of the “Voice” is **Medium**. Unless you need very loud voice prompts you should use the medium setting to conserve battery power. When you are happy with the loudness of the beep tone, press 0 or F1 to exit.

Keypad Tone

Keypad Tone	ON	OFF	4
-------------	-----------	-----	----------

The “**Keypad Tone**” is the key click that you hear each time a key is pressed. Press the “**4**” key to toggle this On and Off.

LCD Options

4 / 6 Line Legacy Mode

4/6 Line Legacy Mode	OFF	4	6	1
----------------------	------------	---	---	----------

The 7150 & LT7250 Terminals are backward compatible with the LT701 6-Line and 4-Line display modes. This will enable you to use the LT7150 without making any changes to your software that you use with your LT71 or LT701. This is host software compatibility only and the LT7150 *will not communicate* with the B551 or B55 Base Stations.

Background Color

Background Color	0, 1 , 2, 3, 4, 5, 6, 7, 8, 9, A, B, C, D, E, F	2
------------------	--------------------------------------------------------	----------

The default background color can be set to one of 16 different values. Each time you press the “**2**” key a small rectangle will show the selected background color with the current text color. The default value is **1** for **Black**. You can find more information about colors in chapter X.

Text Color

Text Color	0, 1, 2 , 3, 4, 5, 6, 7, 8, 9, A, B, C, D, E, F	3
------------	--------------------------------------------------------	----------

The default text color can be set to one of 16 different values. Each time you press the “**3**” key a small rectangle will show the selected text color with the current background color. The default value is **2** for **Blue**. You can find more information about colors in chapter X.

Brightness

Brightness	LOW, MED , HIGH	4
------------	------------------------	----------

The default brightness of the LCD is medium which works well for indoor use. In high ambient light areas, like outdoors, you may want to increase the brightness of the display. Increasing brightness shortens battery life.

Brightness Timeout

Brightness Timeout (in seconds)	00.. 05 ..99	5
---------------------------------	---------------------	----------

This setting controls the timeout for the display to dim after a key is pressed or data is displayed on the LCD. The dim setting is the same as the LOW brightness setting so if you have the brightness above set to LOW you will not see any effect from the timeout. Dimming the display helps extend battery life. The default is **05** for 5 seconds. A setting of 00 will disable the timeout and keep the display always at the standard brightness level.

Other Settings

Preamble

Preambles are user-defined data that is attached to the beginning of data (bar code or keyed) that is transmitted to the host by the RF Terminal. For example, if you set a preamble of @@ and scanned bar code data of **12345**, @@**12345** would be transmitted to the host.

By default, the RF Terminal has no preambles configured. Preambles can contain up to 15 characters entered from the keypad or scanned from the bar coded FULL ASCII Menu. **To set a preamble:**

1. Select option “**8**” from the **RF Terminal** Setup menu then “**1**” for **Preamble** from the **Other Settings** menu.
2. Enter the desired characters (up to 15). Pressing the shift key will turn the cursor red to indicate that the shift is active. Pressing shift again will turn the cursor white and return to unshifted mode.
3. Press “**ENTER**” when you are finished entering data.
4. To clear the **Preamble** and return to the default (no Preamble defined), press “**CLEAR**”.

You can use the **Preamble** to trim characters from the data you are entering into the RF Terminal. You can trim from 1-15 characters from the data by creating a preamble of:

~x

where ~ is ASCII 126 and x is a single hex digit 1-F (corresponding to 1-15). Data that is shorter than the trim amount is transmitted without trimming. **Preambles** trim characters from the front of the data. Here are some examples:

Data	Preamble	Data Transmitted
123	XYZ	XYZ123
12345678	~3XYZ	XYZ45678
12345678	~9	12345678
12345678901	~A	1
123456	~5	6

Using the Bar Code ID feature and the **Preamble**, you can trim data selectively, trimming characters only on the bar code type specified. To use selective trimming, enter:

~bx

where b is the Bar Code ID character (see the *Code 128 setup parameter*) and x is the number of characters to trim from the front of the data. For example, ~b2~c1 says “trim 2 characters from Code 39 data and 1 character from UPC-A data”. Remember that the **Preamble** trims leading data. This applies to One-Way and host prompted communication.

Lastly, the **Preamble** can be used to check a minimum/maximum data length for bar code data entered. To check for bar code length in the **Preamble** enter:

|nnmm

where | is ASCII 124, nn is the two-digit minimum and mm is the two-digit maximum. |0210 would check for a minimum of 2 characters and a maximum of 10. If you try to scan a bar code outside the minimum or maximum lengths, no decode will result. Entering data by keypad is not affected.

Postamble

Postambles are user-defined data that is attached to the end of data (bar code or keyed) that is transmitted to the host by the RF Terminal. For example, if you set a Postamble of @@ and scanned bar code data of **12345**, **12345@@** would be transmitted to the host.

- By default, the RF Terminal has no Postambles configured. Postambles can contain up to 15 characters. **To set a Postamble:**
- Select option “**8**” from the **RF Terminal** Setup menu then “**2**” for **Postamble** from the **Other Settings** menu.

- Enter the desired characters (up to 15). Pressing the shift key will turn the cursor red to indicate that the shift is active. Pressing shift again will turn the cursor white and return to unshifted mode.
- Press “ENTER” when you are finished entering data.
- To clear the **Postamble** and return to the default (no Postamble defined), press “CLEAR”.

You can use the **Postamble** to trim characters from the data you are entering into the RF Terminal. You can trim from 1-15 characters from the data by creating a Postamble of:

~x

where ~ is ASCII 126 and x is a single hex digit 1-F (corresponding to 1-15). Data that is shorter than the trim amount is transmitted without trimming. Postambles trim characters from the end of the data. Here are some examples:

Data	Postamble	Data Transmitted
123	XYZ	123XYZ
12345678	~3XYZ	12345XYZ
12345678	~9	12345678
12345678901	~A	1
123456	~5	1

- Using the Bar Code ID feature and the **Postamble**, you can trim data selectively, trimming characters only on the bar code type specified. To use selective trimming, enter:

~bx

- where **b** is the *Bar Code ID character* (see the *Code 128 setup parameter*) and **x** is the number of characters to trim from the end of the data. For example, ~b2~c1 says “trim 2 characters from Code 39 data and 1 character from UPC-A data”. Remember that the **Postamble** trims trailing data.
- Lastly, the **Postamble** can be used to check a maximum character length for data entered. To check for length in the **Postamble**, enter:

|nnmm

where | is ASCII 124, *nn* is the two-digit minimum and *mm* is the two-digit maximum. |0210 would check for a minimum of 2 characters and a maximum of 10. If you try to scan a bar code outside the minimum or maximum lengths, no decode will result. Entering data by keypad is not affected.

Characters

This setting allows the RF Terminal to output chosen ASCII characters in place of the actual characters entered. For example, if you scanned the number **1** (*hex 31*) and wanted the RF Terminal to output *hex 92* instead, you would enter **3192** for the **Characters** parameter. This would re-assign the output characters, with the RF Terminal outputting *hex 92* every time it sees *hex 31*. To re-assign characters:

- Select option “8” from the **RF Terminal Setup** menu then “3” to enable character entry. A square cursor will appear.
- Enter up to seven 4-digit pairings where the first 2 digits represent the hex number to *replace* and the second 2 digits represent the hex number to *insert*. You can have up to seven character reassignments.
- Press “Enter” when done or “Clear” to reset to none.

You can eliminate the output of a character by using **FF** as the hex number to insert. For example, if you wanted to eliminate all \$, following the above instructions, enter **24FF**.

Data Encryption

Beginning with firmware version R7U301 and B5U301 data encryption is available. Both the Base and the Terminal must have xxx301 or later firmware and have matching “KEYS” to communicate. The default is no encryption so any Terminal can talk to any Base. Relays are not affected and do not need to be running firmware xxx301 or later.

The Encryption Key on the Terminal is set in the **OTHER SETTINGS** menu. Select option 4 to enter the KEY. The key can be any 8-digit hex value. Valid characters are 0-9 and A-F. Use the shift key to enter the alpha characters. 00000000 and FFFFFFFF are invalid keys. Setting the Encryption Key to either 00000000 or FFFFFFFF will disable data encryption. For more robust encryption, avoid using 0 and F. A Terminal with Data Encryption set will display an “E” after the 7001 on the opening screen.

The Encryption Key on the Base is set using the Worth Data *Integrated Hardware Utilities* program can be downloaded from the Worth Data website. Start by connecting the Base to a PC then run the Hardware Utilities on the PC that is connected to the Base. From the menu on the left select “7000 Series Terminal” then “Base Configuration”. If you know the COM port that the Base is connected to, enter it in box 2 then click the button to connect to the Base. When the Base is found it's configuration is displayed. Check the box to enable Data Encryption and enter the same 8-digit value that was entered on the Terminal. Once the value is stored into the Base, cycle power on the Base to restart it using Data Encryption. The LED will blink RED to indicate that the Base has Data Encryption enabled.

If a Terminal attempts to Sign On to a Base with a non-matching Key the Terminal will display the error: “Invalid Command”.

Site Test is not affected by Data Encryption and should always work if a Terminal and Base are within range of each other.

System Tools

Play Voice Prompt

To play a voice prompt, select option “1” then enter the 2-digit number of the voice prompt that you wish to play. The valid range is 01 to 99.

Reset to Factory Default

Select option “2” to reset all setup values to the factory default values. This will reset all values in all menus of the **RF TERMINAL SETUP**.

Language

Select option “3” to select the Language **1: ENGLISH, 2: FRENCH**

Wait for Prompt Msg.

Select option “4” to toggle the “Waiting for Prompt from Host” message **ON/OFF**. Slower host computers may cause this message to flash more frequently so it may be desirable to turn it OFF.

Password for Setup

Select option “5” to toggle the setup password **ON/OFF**. The setup password is “WDTRI” and cannot be changed.

Site Test Single

Select option “6” to run a single Site Test – this tests the performance of the Radio at your “Site” or location.

Site Test Continuous

Select option “7” to run a continuous Site Test – this test allows you to check the performance of the Radio at your Site while moving around to see exactly where the RF is performing well or poorly.

Opening Screen Text

Select option “8” to setup the text for the Opening Screen – Default is:

LINE 1 TEXT: 1. – SIGN ON _____ --- 1
LINE 2 TEXT: _____ --- 2

You can change the Text to something that matches the name of your application or task to be done. There are 2 Lines of 20 Characters available.

An example might be:

**1. – PRESS 1 FOR
INVENTORY SOFTWARE**

One Way Mode

Select option “9” to run **One Way Mode** – this mode allows you to do a simple RF test and even a scanning test. You can even receive data from the Base Station serial port – to check transmission of data back and forth. See the [How One-Way Mode Works](#) for more details.

BT Portable Printer Settings:

The LT7150H & LT7250H RF Terminals have a BT wireless radio module built in, and have setup options that allow the RF Terminal to pair with compatible portable printers. Currently only the Serial Port Profile (SPP) is supported. This is the most common profile for portable printers like the Zebra QLn & ZQn series of printers as well as the TSC Alpha Series 3 printers.

BT Printer Setup

Use this command to pair the RF Terminal with a device. First make sure that the printer to be connected is On and ready to be paired. Consult the printer manual for printer specific instructions on pairing. Press #9 to start the pairing process. After a short delay the LT7x50H will display a list of all devices in range. Select the device from the list that you would like to pair with or press 0 to Exit and make no change. The LT7x50H will attempt to pair with the printer and will prompt for a PIN if required. If known, you can also enter the PIN of the printer in advance using option #A of the main setup menu. Once paired, the pairing and PIN information will be saved in the LT7x50H and no further pairing for that printer should be required. If you wish to pair to a different printer just repeat the steps above. Since the LT7x50H can only be paired with one printer at a time, the old pairing and PIN information will be overwritten when the new printer is paired.

All @S commands sent to the printer automatically. If an S-command is sent but no printer has been paired then the LT7x50H will search for a printer to pair with.

Reset BT Module to Default

Use this command to reset the BT module. This should reset the radio and also will remove any pairing.

Pair If Already Paired

Default setting is YES - This will make the Radio pair to the last device that is set in the module. This should help for units that have problems automatically re-connecting after sleep or other conditions.

BT Printer Test

Enter this mode to test the module, including printing a test label to make sure your printer is setup properly and the printer is paired and configured properly. We use the ZPL printing language for this test label. Make sure your printer is set to ZPL mode and has no security set (Security Mode 1).

BT PIN Code

Default setting is no pin code and is displayed as XXXX – Match this PIN Code to the code needed for your Printer and enter it into the scanner.

Chapter 3: Base Station & Relay Setup

Base (B5011) and Relay Setup

The Base and Relay Setup is only accessible via the *Hardware Utilities 3.0* which you can download from our website at: <http://www.barcodehq.com/downloads.html>

Using the Hardware Utilities 3.0

After you install the *Hardware Utilities 3.0*, make sure your Base Station or Relay is attached to a USB port, or one of the computer COM ports using the 9 pin serial cable (F36), or 25 pin serial cable (F34) included with your system and that the power supply (5v from Worth Data ONLY) is plugged in – a power supply is not needed with the C21-2 USB cable connection in most situations. **When powered up a Base Station will blink Green 3 times (for RF channel 0) - while a Base configured as a Relay will blink Orange 3 times (for RF channel 0)**, so be sure your unit is configured properly.

Start the RF Base Station Configuration Utility.

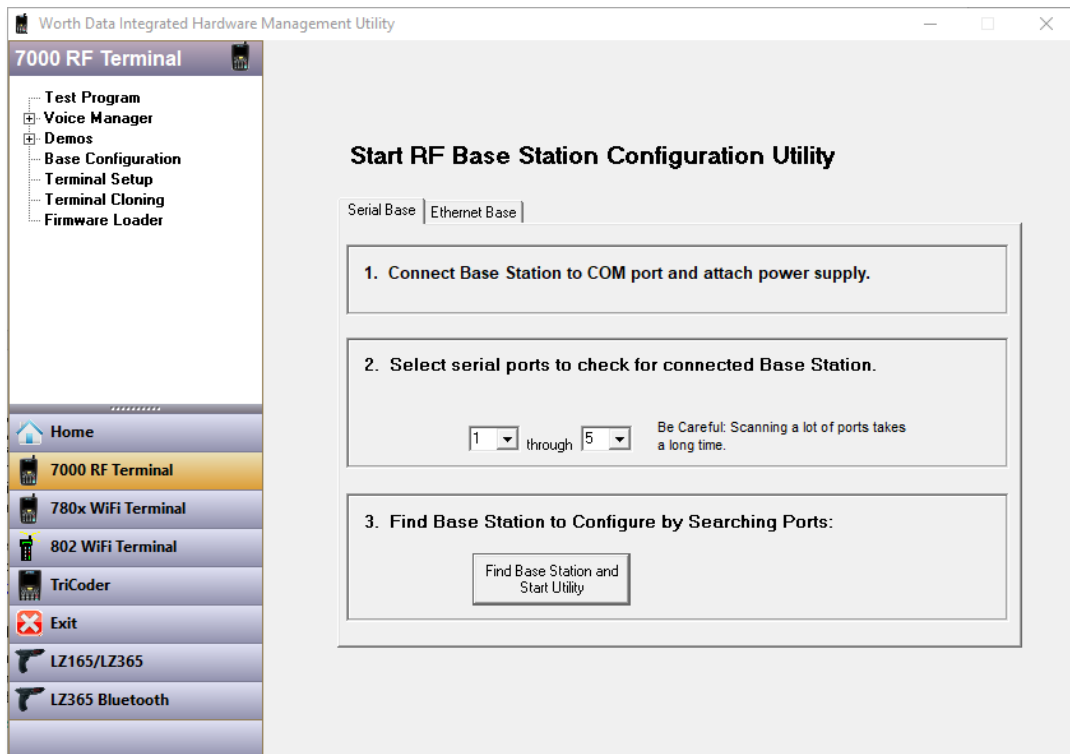

If you know which COM port you are attached to, select that port in the program then click "**Continue**". If you are unsure of the COM port number, the program can find it for you. Enter the range of COM ports to search, then click "**Find Base Station**".

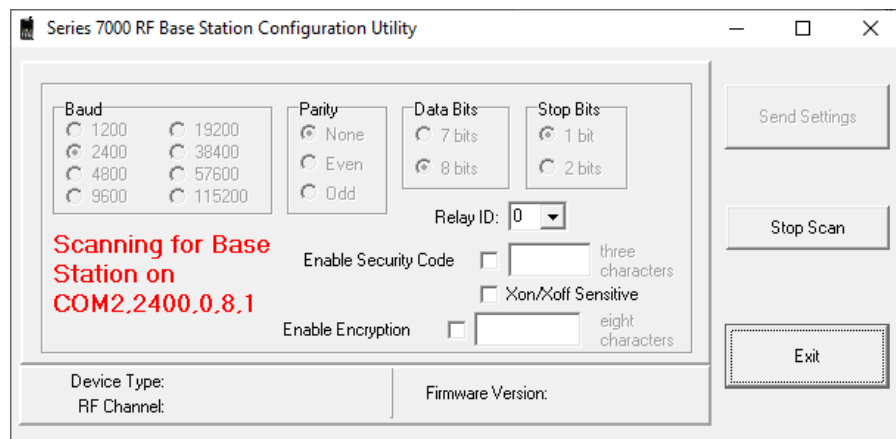

The program will look for the Base or Relay and determine its current configuration. Once the program finds it, it will display the Device Type (BASE or RELAY), the RF Channel (default is 01) and the Firmware Version (xxxx-pp). The first five characters are for the main processor's firmware, which can be updated by you from the latest firmware always available on our website. The last two characters are the firmware version of the radio processor; this is not field updateable. If these two characters don't show, (you see only xxxx), it means your radio processor is not responding and you need to call us to authorize a repair.

If you want to change any of the settings (**Baud, Parity, Data Bits and Stop Bits**), you can do so by clicking the desired setting.

If you are configuring a Relay, the first Relay should be configured as **Relay ID "0"**, which is the default. If you have more than one Relay, then select the desired Relay ID for this unit.

You can enable a **Security Code** for either a Base or a Relay. The Security Code needs to be three characters and when enabled, requires anyone wanting to make a change to the Base or Relay to enter this 3-character code.

"**Xon/Xoff Sensitive**" should be checked **ONLY** if your system has XON/XOFF specified for handshaking on the serial port in use. Typically in Windows, handshaking will be set to "None" and you should leave this setting unchecked. See "*Addressing a Terminal not Signed In*" and "*Base Station Initialized Message*" in **Chapter 6** for details.

Once you have made any and all changes, click on the "**Send Settings**" button. Your Base or Relay is now configured!

Testing the RF link between base station and host

Use the following command to test the transmission of data from host to Base and back again to the host:

```
@@*Edataaaaaaaaa<EOT>
```

where *dataaaaaaaaa* is any string of data, terminated by EOT. This string should be sent from the host to the Base Station. If the data is received by the Base, it is echoed back to the host in the format:

```
dataaaaaaaaa<CR>
```

where *dataaaaaaaaa* is the data string from the original transmission, terminated by a CR (ASCII 13). This test verifies communication in both directions (host to Base, Base to host).

- If the data isn't echoed back, either your host COM port or the Base Station has a problem.
- Once you know the Base Station is communicating with the host correctly, compare the channel of the Base Station with the channel of the Terminal. Use Site Testing to check the communication of the Terminal to the Base and back. Stay close, make sure no other Terminals are in use, and go to Site Test mode on the Terminal. You should get 90-100% on first try. If you don't, it's a good chance your radios need repair. Call Worth Data for an RMA.

If you are using PICK or UNIX as your operating system, make sure the Base Station is set to "XON/XOFF Sensitive".

Opening a Base

As preparation for changing the Channel on a Base Station or changing the Base to operate as a Relay, the case must be opened to expose the circuit board with the switches and jumpers. Be sure you disconnect power before opening the case.

Turn your Base Station upside-down, and unscrew its single phillips head screw. If you don't completely remove the screw, you can use it as a lever to pull up on the cover.

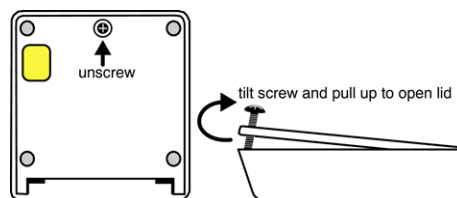

Otherwise, insert a fingernail, credit card edge or small screwdriver blade into the gap between the Base and side of the case, and gently use it as a lever to lift up the edge of the Base. Then grasp the edge of the Base and open it outward like a door.

Changing a B5011 Base to a Relay

Moving the jumpers to any of the Relay positions causes the B5011 Base Station to operate as a Relay. A Base station will blink Green on power up; a Relay blinks Orange on power up.

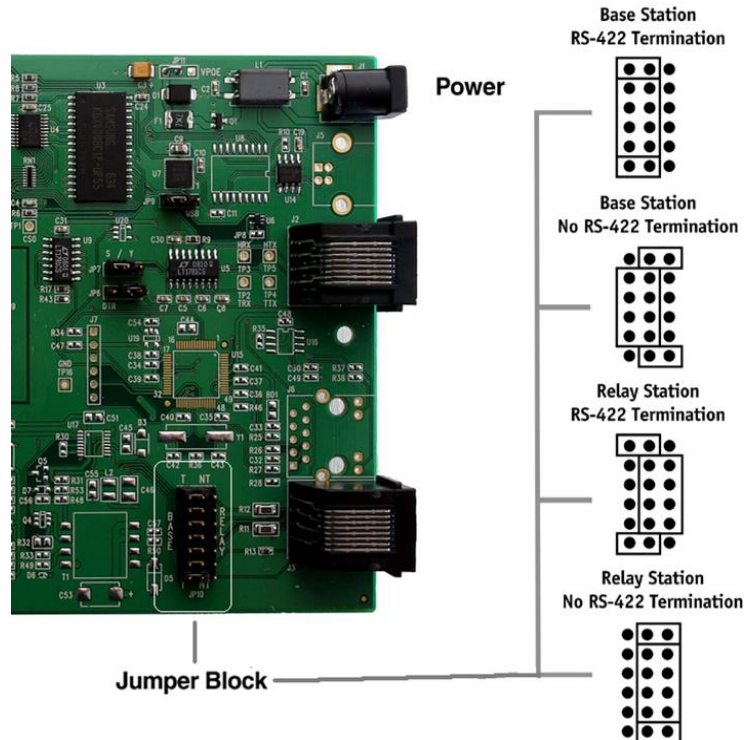

RS-422 Termination Jumpers

Refer to the circuit photo above for details.

The Base can be jumpered to be RS-422 terminated or not terminated. By default, all Base stations are shipped as *terminated*. Use the following guidelines to change the termination for your system:

- If the Base has multiple strings of relays radiating from it, the Base would **not** be terminated.
- If the Base is first in a string, (not in the middle or end of a string), set the 422 jumpers to **Base w/RS-422 termination**.
- The last Relay in each string should have its jumpers set as a **Relay w/RS-422 termination**.

RF Channel Changes

To determine the current channel of a Base Station, power up the Base and watch the LED light on the front of the unit. On power UP, a Base LED will blink Green "RF channel +3" times. For example, a unit that blinks 5 times green on power up is operating on **channel 2 as a Base Station**. Channel 0 blinks 3 times (the default channel), channel 5 blinks 8 times.

RF CHANNEL	JUMPERD FOR BASE STATION	JUMPERED FOR RELAY
0	● OFF ● OFF ● SOLID	● OFF ● OFF ● SOLID
1	● OFF ● OFF ● OFF ● SOLID	● OFF ● OFF ● OFF ● SOLID
2	● OFF ● OFF ● OFF ● OFF ● SOLID	● OFF ● OFF ● OFF ● OFF ● SOLID
3	● OFF ● OFF ● OFF ● OFF ● OFF ● SOLID	● OFF ● OFF ● OFF ● OFF ● OFF ● SOLID
4	● OFF ● OFF ● OFF ● OFF ● OFF ● OFF ● SOLID	● OFF ● OFF ● OFF ● OFF ● OFF ● OFF ● SOLID
5	● OFF ● OFF ● OFF ● OFF ● OFF ● OFF ● OFF ● SOLID	● OFF ● OFF ● OFF ● OFF ● OFF ● OFF ● OFF ● SOLID
ALT RF CHAN		
A	● ● ● ● ● SOLID	● ● ● ● ● SOLID
B	● ● ● ● ● ● SOLID	● ● ● ● ● ● SOLID
C	● ● ● ● ● ● ● SOLID	● ● ● ● ● ● ● SOLID
D	● ● ● ● ● ● ● ● SOLID	● ● ● ● ● ● ● ● SOLID
F	● ● ● ● ● ● ● ● ● SOLID	● ● ● ● ● ● ● ● ● SOLID
E	● ● ● ● ● ● ● ● ● ● SOLID	● ● ● ● ● ● ● ● ● ● SOLID

Changing the RF Channel on a Base/Relay

The Base Station, and its related Relays, must have their channel set to the same channel as the RF Terminals in their network. The channel is set on a Base or Relay by turning a rotary switch to the setting 0-5 (6 different channels to choose from) for the Standard RF Channels – and A-F for the newest Alternate RF Channels. Use a very small flat head screwdriver to turn the switch to the desired number. See the circuit board photograph to the right – the location of the rotary switch is near the top left corner - newer units can be adjusted by turning the small knob by hand.

Note: RF Channels A-F can only be used with the latest RF Terminals and Base Stations manufactured in 2022 and onward.

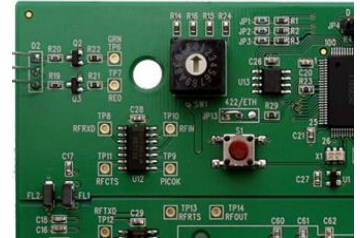

Setting the Relay ID

Each Relay must also have a unique ID, which is set by the RF Terminal Base Configuration Utility in the *Hardware Utilities* software.

Adding B5011 Relays

Connecting a B5011 Relay Station

A B5011 Relay station allows you to extend the area of your RF coverage. Relays are connected by cable to the main B5011 Base station, acting as a remote antenna. More than one Relay can be added by “multi-dropping” additional Relays. Using a Relay requires changing the setup on the Base station in addition to added cabling. The diagram below shows how Relays are added:

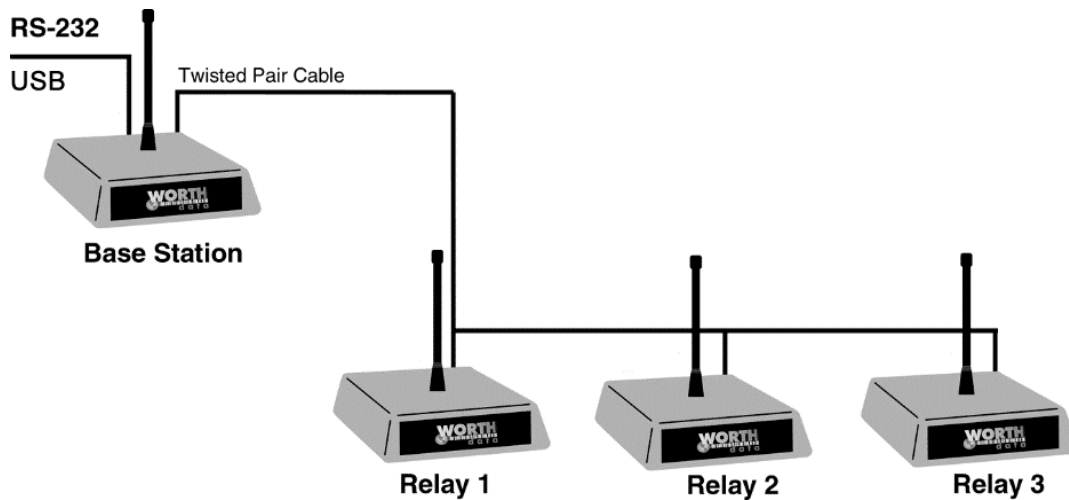

Although Relays will extend your RF range, they do slightly slow down your response time. If response time is your problem, Relays may help *only* if the problem occurs on the *outer limits* of your range. Use the **Site Test** tools to help you determine if adding a Relay will help.

If adding only one Relay, the cabling should run between the “RELAY/NET” port on the Base station and the “RELAY/NET” port on the Relay. In this example, both the Base Station and Relay should have jumpers set to “terminated”.

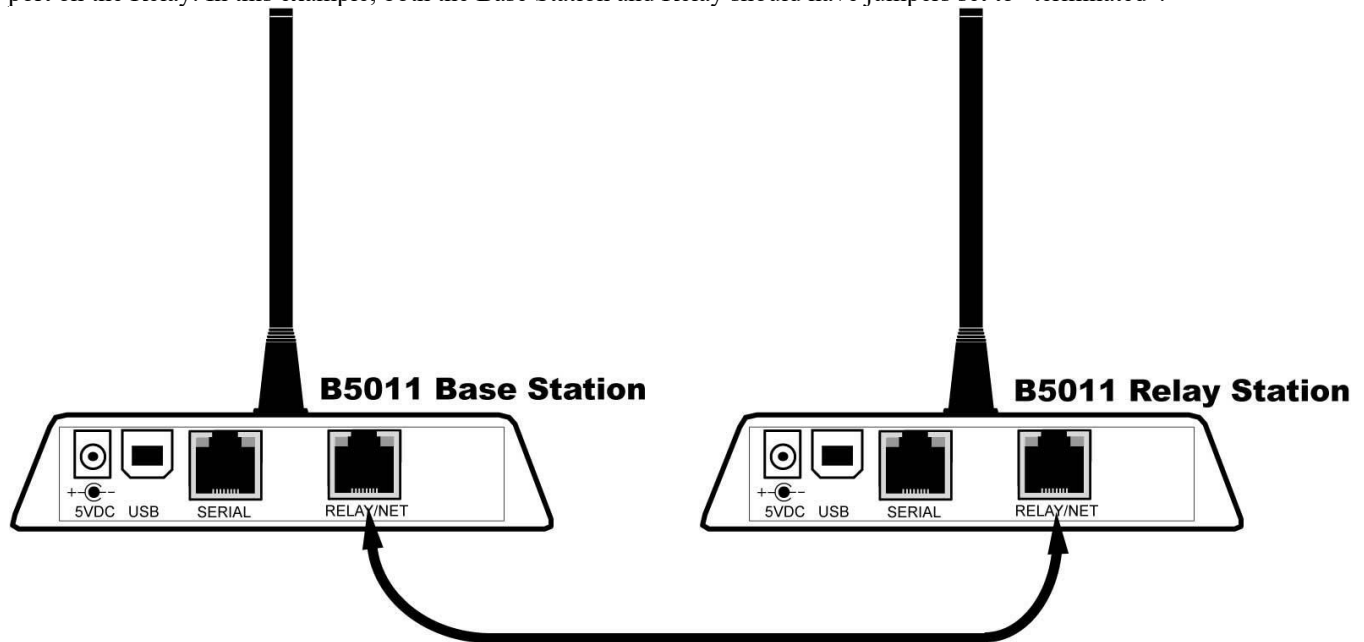

To add additional Relays, you must “multi-drop” them off a single bus line running from the “RELAY/NET” port on the Base station. See the section below for cabling requirements and pin-outs. It is very important to follow the pin-out directions carefully and to use the suggested cable type. The majority of problems we see are the result of incorrect wiring.

Each Relay requires its own power supply. There is no serial parameter setup required on a Relay as it is transmitting only to the Base station and not directly to a serial port.

Connecting Multiple Relays using a RJ45 Junction Block

The diagram below illustrates the **RIGHT** way to route your wiring and which units should be terminated. The bottom of the RJ45 Junction Block (1-2 Splitter) is connected into the unterminated Base or Relay(s).

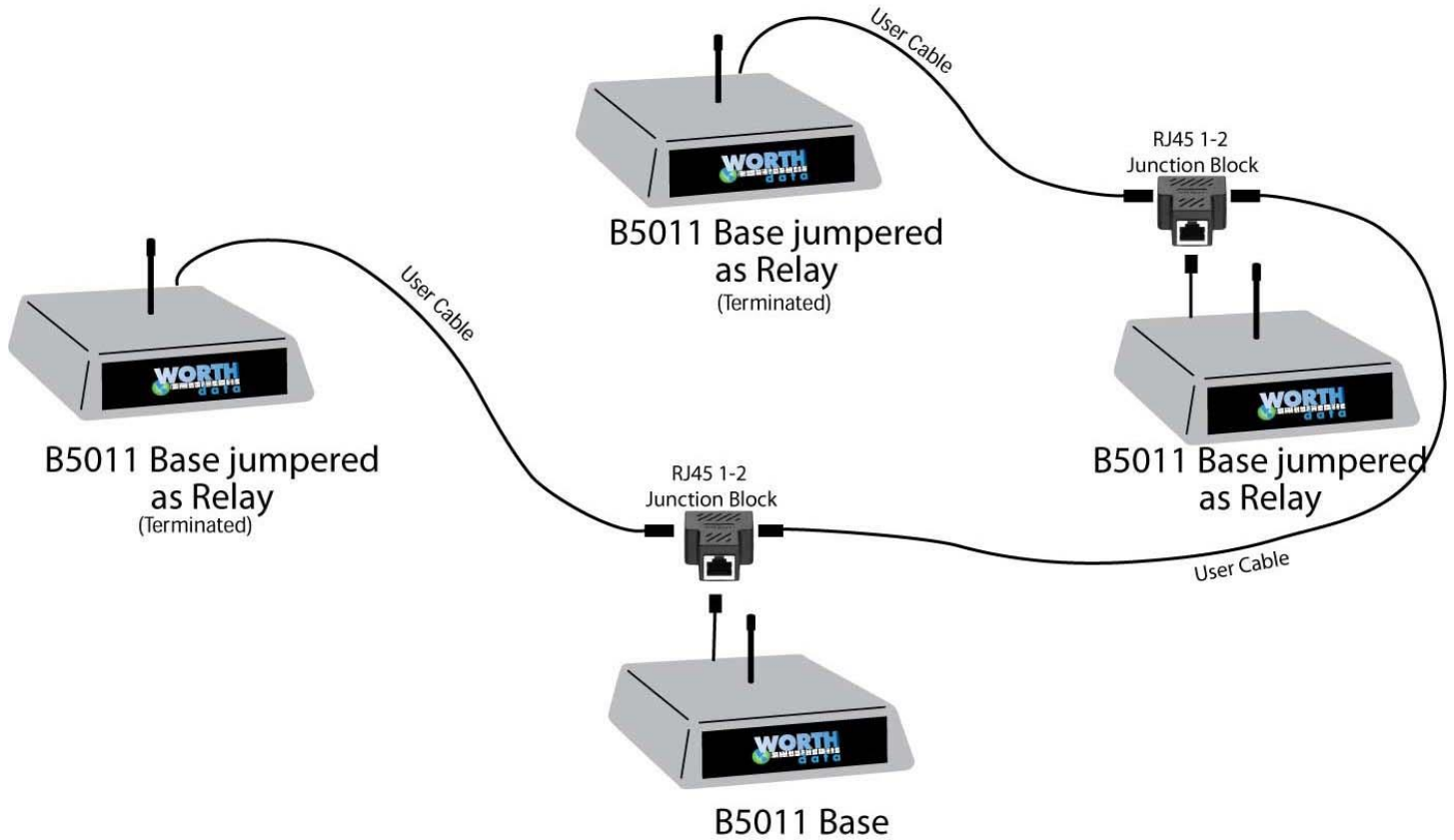

Notice that the two end units are terminated; the units in the middle are unterminated, including the Base in this example. Keep in mind that the maximum total cable length from end-to-end is 4000' for good quality twisted pair wire.

Below is an example of two types of RJ45 Junction blocks that will work as shown in the diagram above. These are also called a **1-2 RJ45 Splitter**, or a **RJ45 Coupler**.



The next diagram illustrates the **WRONG** way to route your wiring and use the Y-cables. Sometimes people try to route everything through a panel or wiring closet – this will not work properly; it will generate excessive data noise and drag down the responsiveness of the Base and application. (With too much noise, the Base will stop working and issue a “Base Station Reinitialized” message to the terminals. If used, such a radial interface as below might appear to work most of the time, but it would be very sluggish and crash several times per day. Terminating or not terminating will be of no help. Do **Not** cable as shown below:

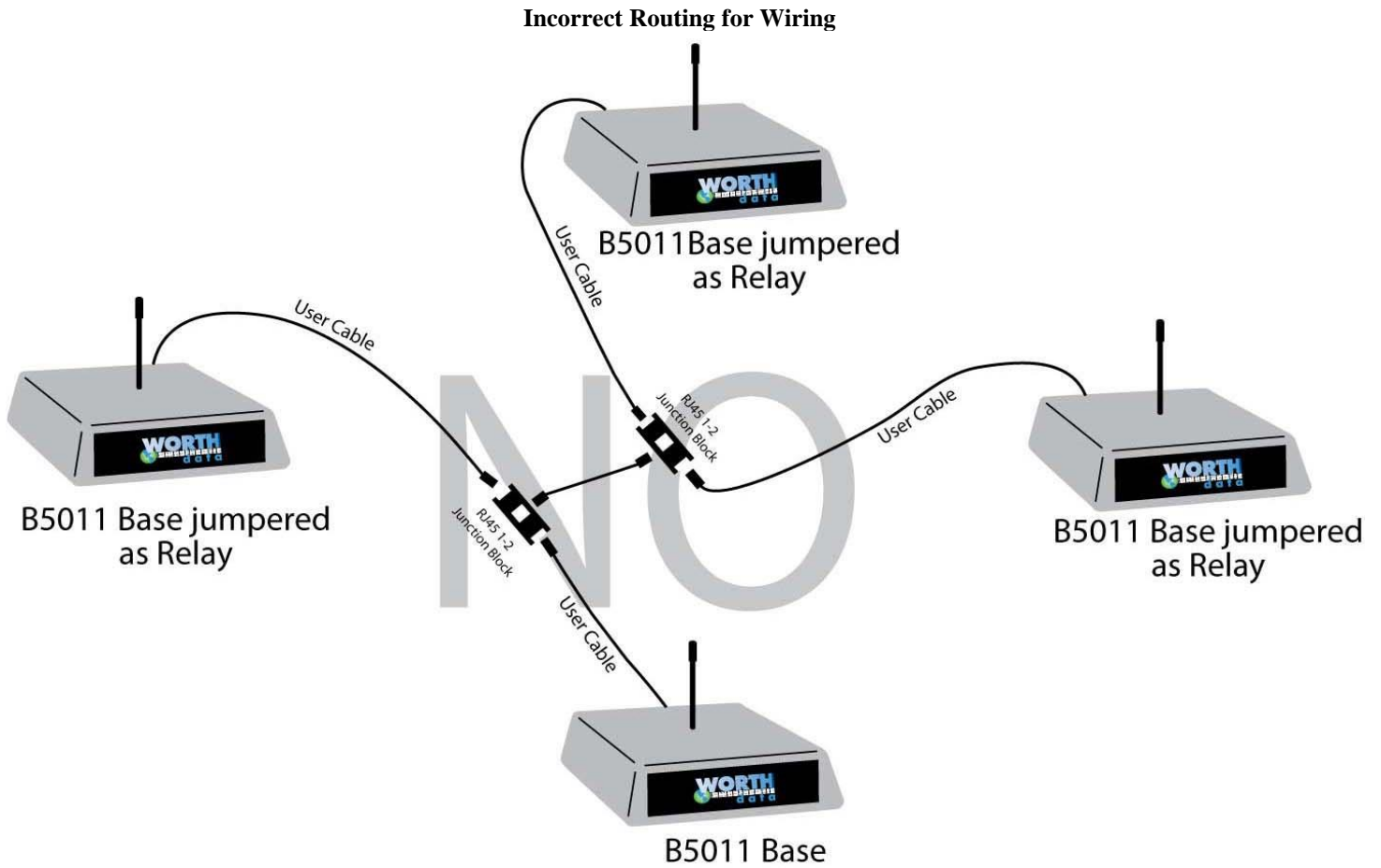

B5011 Relay Station RS422 Pin-outs

The B5011 Relay Stations are connected by twisted pair wire -- use **Belden 1227A1, Cat 5 wire**, or equivalent. The “RELAY/NET” port on the **Base Station** and the “RELAY/NET” port on the **Relay Station** are connected with a straight cable using the following pin-outs:

Base Connector	Pin #	Relay Connector
Receive Data +	5	Transmit Data +
Receive Data -	6	Transmit Data -
Transmit Data +	2	Receive Data +
Transmit Data -	3	Receive Data -

Make a cable with 5-5, 6-6, 2-2, and 3-3 (a straight cable); but, be careful that you select wires so that the 2 wire is in the twisted pair with the 3 wire, and the 5 wire is in the twisted pair with the 6 wire. **Do not use pre-terminated Ethernet cables since the pairing is different.**

For all RJ Cable pin numbers, number from left to right with the metal pin side of the connector facing you and the cable running to the down position

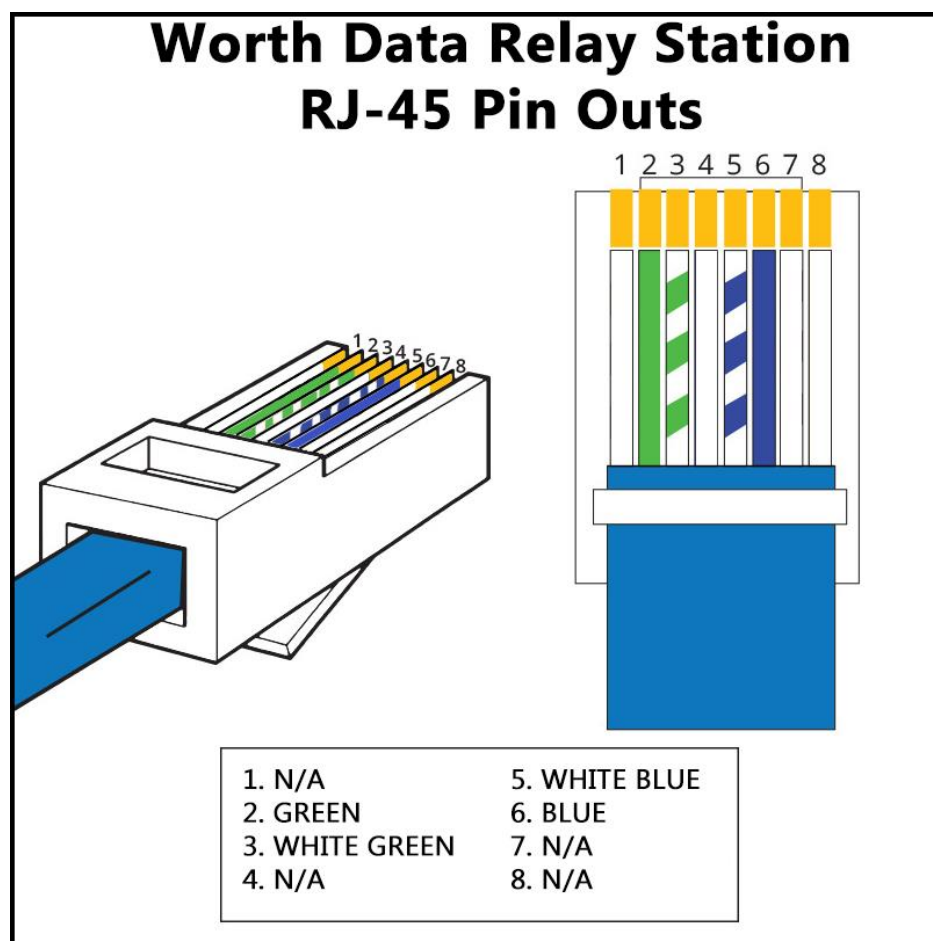

B5011 Relay Test Plan and Failures

Relay Station failures are often cable-related. If a Terminal puts out a “Who Can Hear Me?” message and a Relay that is for some reason *not* connected to the Base Station (bad cable, cut cable, broken connectors) hears it, it answers with the message:

**Relay n Cannot Be
Heard by the Base
Notify Supervisor
Press Any Key**

At this point, it is up to the operator to notify someone that the Relay is not communicating with the Base and to check the cabling *first*. There is no message sent to the host, so it is very important that the operator that receives this message notify someone immediately.

Because relay cabling is often troublesome, we supply a test cable for isolating the user-made cable from the process.

HINT: Use the suggested wire type, and if you're doing your own crimping, be sure to use the good metal crimpers. Get someone familiar with making network (Ethernet) cables, but be sure to tell them **not** to use the Ethernet pin outs for the Relay Stations, (it has been tried more than once!).

Testing the B5011 Relay

To test RF communication with a Relay, first check out the radio by doing a **Site Survey** with the Relay Station in question powered up and the RF Terminal at around 20-50ft away – Note: all other Relays and Bases need to be OFF. A Relay will power up with an Orange LED.

To check if a Relay is cabled properly and working with a Base Station, set the Base to a *different* RF channel than the Relay and set the Terminal RF channel to match the Relay channel. Then cable-connect the Relay to the Base (“RELAY/NET” port to “RELAY/NET” port). Make sure **Relay Existence** is set to “ON” in the RF Configuration setting for the RF Terminal.

Start your application on the host, or use one of our demo programs provided with the Terminal (it's a good way to test) - it takes 10 or more seconds for the Terminal to switch to the Relay. The delay is a result of the Terminal having to put out a "who can hear me" message when it doesn't get a response from the Base Station. The Relay responds to the Terminals "who can hear me" message and communication is established through the Relay. You will notice slightly slower throughput when working through the Relay.

Relay ID and RF Channel...

Relays should typically always be set to the same channel as the Base station and RF Terminals that you will be using in your system. Determining the current channel is the same as on the Base station; power up the Relay and count the number of times the LED flashes Orange – it will then blink the number to correspond to the RF Channel (channel + 3). The default setting is channel 0 (3 flashes). Each Relay also requires a unique Relay ID; the default ID is 0. **A Relay will blink Orange; a Base blinks Green.**

Changing a Relay back to a Base

You can convert the Relay back to a Base Station by setting the Base/Relay jumper to the Base position. You can check the outcome by simply powering up the unit - a Base LED will be green; a Relay will be Orange.

Changing the RF Channel on a Relay

The Relay is normally set to the same RF Channel as the main Base Station and all of the RF Terminals in their network. The channel is set on a Relay by turning the rotary switch to the setting 0-5 for the Standard RF Channels, or the Alternate RF Channels A-F. Use a very small flat head screwdriver, or turn the knob by hand, to select the desired number. In some cases it may be desirable to have a Relay on a different RF channel than the main Base Station.

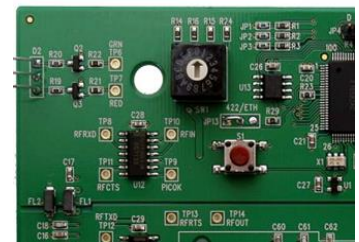

Setting the Relay ID

If you only have one relay, there is no need to set the Relay ID which is shipped default as relay 1. If you need to change it or you have multiple relays, it must be changed using the *RF 7000 Base Serial Configuration Utility* in the **Hardware Utilities** program.

RS-422 Termination

When adding Relays to a system, the last Relay(s) in the line(s) must be terminated. By default, all Base stations are shipped as terminated. Use the following guidelines to change the termination for your system:

Refer to the circuit board diagram on the previous page for details.

- If the Base has multiple strings of relays radiating from it, the Base would **not** be terminated but each Relay would.
- If the Base is first in a string, (not in the middle or end of a string), set the 422 jumpers to **Base w/RS-422 termination**.
- The last Relay in each string should have its jumpers set as a **Relay w/RS-422 termination**. Any Relay that is *not* the last relay in the string would *not* be terminated.

Optimum coverage for Bases and Relays

As we said before, it is almost impossible to predict the effective RF communications range in a given environment. The typical area of coverage is a 3,000 – 10,000 ft. radius.

After a Site Test survey, if you have determined that you will need to add Relays to cover the area you want to operate in, you will need to determine where to place your Relay in relation to your Base Station. To effectively cover an area, there must be overlap between the area covered by the Base Station and the area covered by the Relay. The example on the right shows what can happen with no area overlap:

Keep in mind that the maximum length of wire that can run between a Base and a Relay or from Relay to Relay is 4000 feet. In most cases the range of the LT7x50H to the Base will exceed this amount unless you are operating in a very challenging environment.

As you can see, the only area adequately covered is in a path where the two circles touch. The “dead space” is completely without coverage. Alternatively, locating the Base Station and Relay as shown below results in better coverage:

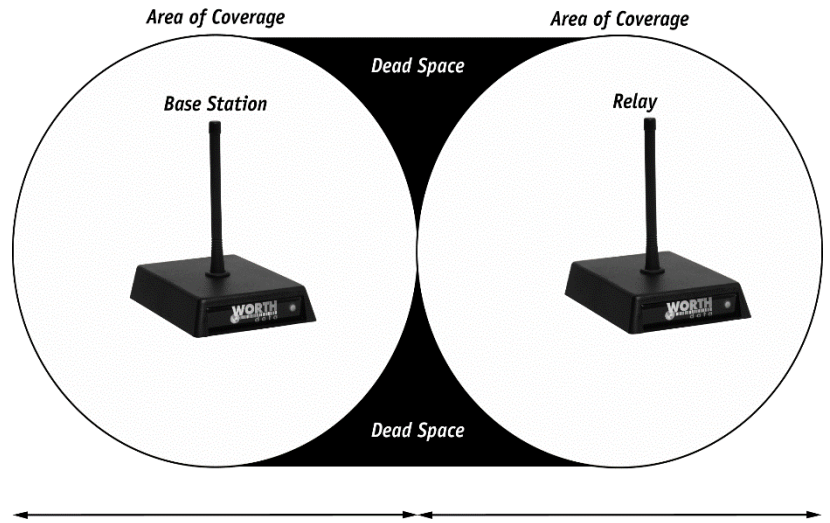

To Site Survey a Relay, all other Relays and Base Stations must be turned off. This is the only way to know for sure which Relay is responding. Alternatively, perform the Relays' test out of range of the other Relays and Base Stations.

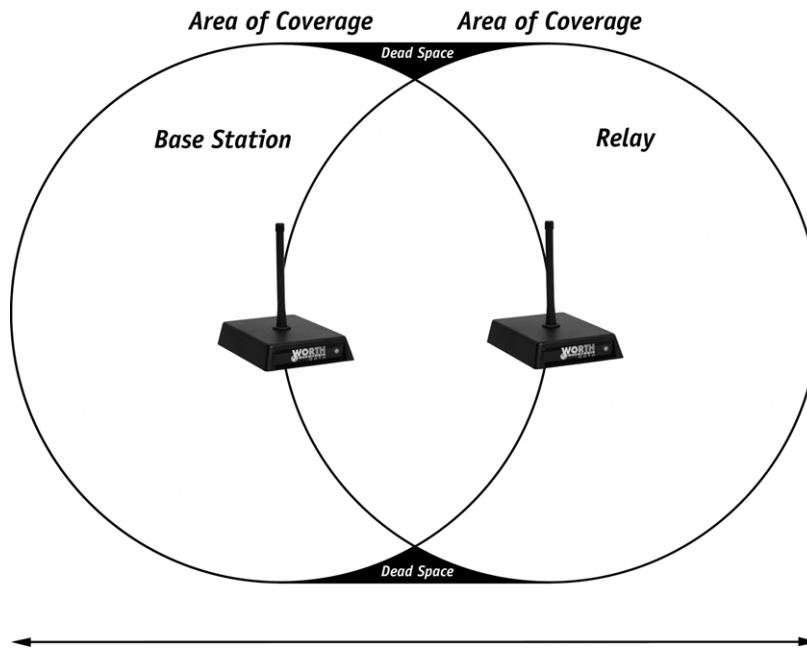

Is radio traffic contention likely?

The radio traffic time is about 30ms per transaction. Radio time is not going to be a gating factor, even with more terminals than the allowed 64 maximum.

The bottleneck could partially be the serial port baud rate in high volume applications. The default baud rate is 9600 baud; you can increase this up to 115,200 baud, but the greater the baud rate, the less the RS-232 cable distance allowable. With USB connections 115,200 baud is not a problem and would be recommended for maximum speed.

The gating factor for the application is almost always going to be the application program. By splitting the application between two or more work stations, each talking to a separate set of Terminals/Base Station, that factor can be minimized.

Base Station Cable Options

The **B5011 Base Station** and **B5021R Ethernet Relay** are connected to a PC with one of the following cables:

C21 USB Cable

This is standard full size A-B USB Cable that is 6 feet long.

F36 DB9 Straight Cable

These are the pin-outs for Cable F36, a DB9 Female to 8 pin modular RJ45. This cable is used to connect the Base to a 9 pin Male host serial COM port.

Mod 8 RJ45	Function	DB 9 Female
1	Shell (chassis ground)	Shell
2	Transmit Data	2
3	Receive Data	3
4	Signal Ground	5

F36 9 pin cable

If you plan on building your own extension cables, you **must** use well shielded cable and you **cannot** use twisted-pair cable. You can order custom length RS-232 extension cables from many companies and often find stock 10 ft., 25 ft., and 50 ft. DB9 straight extension cables.

F34 DB25 Null Modem Cable

These are the pin-outs for Cable F34, a DB25 Female to 8 pin modular RJ45 with pins 2 and 3 crossed, used for a Base connected directly to a 25 pin male host serial COM port.

Mod 8 RJ45	Function	DB25 Female
1	Frame Ground	1
2	Transmit Data	3
3	Receive Data	2
4	Signal Ground	7

F34 Null Modem Cable

Modular Pins 5-8 are connected to DB25 pins 5,6,8,4 but not used by the RF Base.

If you are planning to use a serial extension cable of 80 feet or more, you need to open the DB25 shell of our cable and be sure that only pins 1,3,2, and 7 are connected. All others should be cut. This is necessary to keep Windows from following noise transitions as handshaking transitions that can severely degrade the application or even crash Windows.

For all RJ Cable pin numbers, number from left to right with the metal pin side of the connector facing you and the cable running to the down position

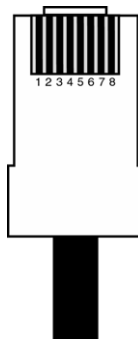

B5021V Connection – Direct Ethernet

The **B5021V Ethernet Base Stations** are connected by Cat 5 wire, or equivalent, to the *RELAY/NET Port* on the **B5021V Base Station**. You must use the CPR software or talk to it directly using its assigned IP address.

B5021R Connection - Ethernet Relay

The **B5021R Ethernet Relay Base Stations** are connected to the host computer with a C21 USB cable, or our F36 DB9 or F34 DB25 serial cables. You use Cat 5 wire, or equivalent, to connect to your ethernet network from the *RELAY/NET Port*. Additional B5021R Ethernet Relay Stations connect via Cat 5 wire directly to the *RELAY/NET Port*.

Ethernet Base (B5021) Setup

This section details the setup of the B5021 Ethernet Base and covers the differences between the B5011 and the B5021. Refer to the [B5011 Setup section](#) for information about the B5021 not related to its Ethernet connectivity.

There are 3 configuration options for the B5021 Ethernet Base Stations

B5021V Base Station – Connects via Ethernet Only

B5021R Base Station – Connects via USB or Serial Cable to the Host Computer

B5021R Relay Stations (Same as B5021R Base Station, just Jumpered for Relay)

The B5021 is similar to the B5011 except the RELAY/NET port on the B5011 has been replaced with an Ethernet port. A **B5021R Base Station** connects to the host computer by USB, RS-232 serial, a **B5021V Base Station** and **B5021R Relay Station** connects only by Ethernet. The only difference between a B5021R and B5021V is they just have different firmware loaded in them, so they can be changed as needed by just changing the firmware.

The Ethernet port supports Power-over-Ethernet (PoE) standard 802.3af which allows you to run a single cable to the **B5021R Relay Station** or **B5021V Base Station** for more flexible installation options. An optional 802.3af compliant power injector is required to supply power over the Ethernet cable to the B5021. The Ethernet port on the B5021 supports 10/100 Mbps operation.

If you plan to power the **B5021V Base Station** or **B5021R Relay Station** using an 802.3af compatible power injector you must set JP11 on the B5021 to the VPOE setting. JP11 is located near the DC jack in the upper right hand corner of the PCB. If you are using the supplied 5V power supply then no change is required.

Installation

The B5021 can operate in one of two different modes depending on which firmware is loaded. The operational mode can be changed by simply changing the firmware. The hardware is the same for both modes.

The first mode of operation is Virtual COM Port (VCP) mode for the **B5021V Base Station**. In VCP mode, a driver is loaded on the Host computer which generates a VCP and allows the Host software to communicate with this VCP in the exact same way as a physical COM port. When the **B5021V Base Station** is connected on the same Ethernet network as the Host computer the VCP will be active and the Host program can communicate with the **B5021V Base Station** over Ethernet instead of serial. Serial and USB port communication (except for firmware updates) is not supported on the B5021V.

The second mode of operation is Ethernet Relay (ER) mode for the **B5021R Base Station** (jumpered as a Base). In ER mode, the **B5021 Base Station** operates exactly like the **B5011** except the RS-422 relay port is replaced with an Ethernet relay port. This allows the **B5021R Base** to communicate with **B5021R Relay Station** over the Ethernet connection. The **B5021R Base** is connected to the Host computer either by RS-232 serial or USB just like the B5011 and requires no changes to the host software. The B5021R Relay can be connected to the same Ethernet network as the B5021R Base or it can be located remotely on a different Ethernet network. Up to 16 B5021R Relays can be connected to a single B5021R Base.

The Ethernet port supports Power-over-Ethernet (PoE) standard 802.3af which allows you to run a single CAT-5 cable to the B5021 for more flexible installation options. An optional 802.3af compliant power injector is required to supply power over the CAT-5 cable to the B5021. The power injector will combine the power and data lines into a single CAT-5 cable. The B5021 will separate the power and data automatically. If you plan to power the B5021 using an 802.3af compatible power injector you must set JP11 on the B5021 to the VPOE setting. JP11 is located near the DC jack in the upper right hand corner of the PCB. If you are using the supplied 5V power supply then no change is required.

The Ethernet port on the B5021 supports 10/100 Mbps operation.

If you wish to reset the Ethernet settings to factory default values, set jumper JP4 to the “D” position then apply power. Wait for the LED to blink 3X then remove power and set JP4 back to the “N” position. This feature is supported in versions B5UE11, B5U305A and later firmware.

B5021 Options

There are 2 different options for installing the B5021. A diagram of each installation option is shown below along with detailed setup instructions for each option.

Keep in mind that the RF Terminal will need to be configured to talk to relays if option #2 listed below is used by setting “Relay Existence”=YES under “RF Configuration”. The default is NO.

Option #1: Virtual COM Port (VCP)

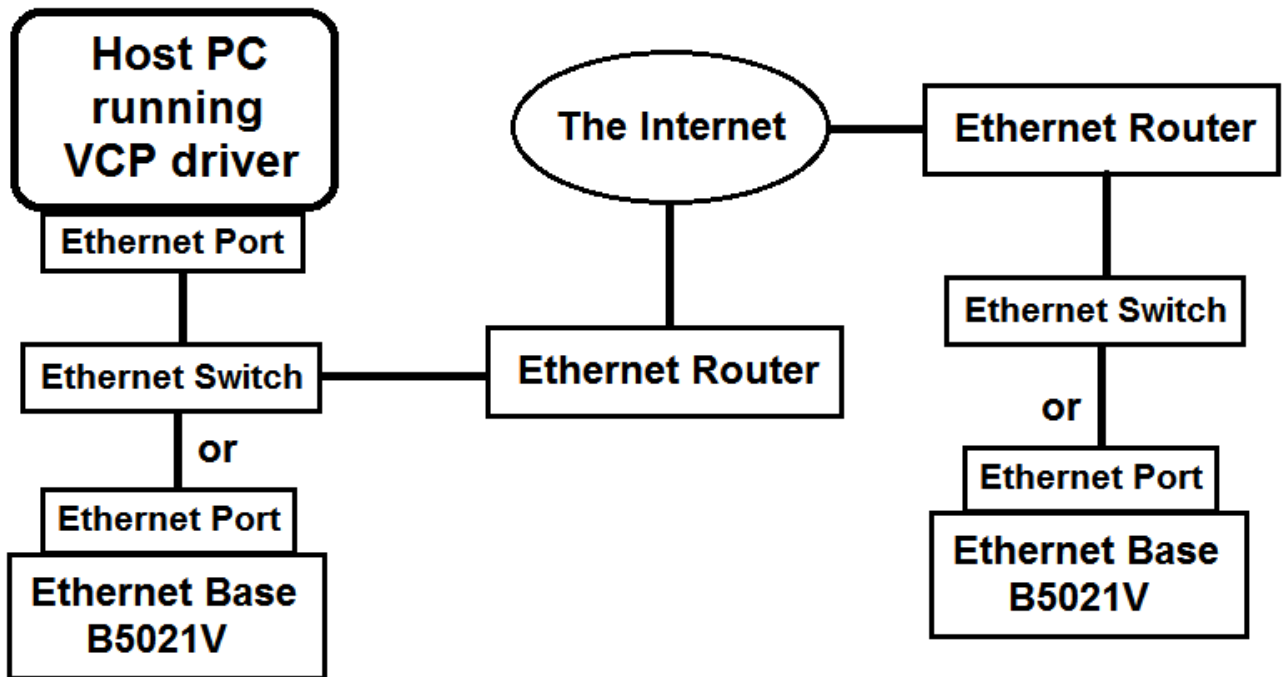

This option allows a **B5021V Base Station** running Virtual COM Port firmware to be connected via Ethernet to the Host PC running a VCP driver. The VCP driver will create a virtual COM port on the Host PC. The application software running on the Host PC communicates with the virtual COM port in exactly the same way as the B5011 does via serial or USB and requires no changes to the Host program to communicate with the **B5021V Base Station**. The **B5021V Base Station** must be located on the same Ethernet network as the Host computer. No Relays are supported by the B5021V. Also, the **B5021V Base Station** does not support Host communication by serial or USB to the Host computer. Only firmware updates are allowed by serial or USB on the B5021V.

The **B5021V Base Station** can be connected on the same LAN as the Host PC or located remotely as shown in the drawing above.

Option #1A: B5021V Installation Procedure (Local Network Only):

1. Power up the B5021V then connect a CAT5 cable between the RELAY/NET port of the B5021V and a hub or switch that is on the same network as the computer to be used to configure the B5021V for the first time. The green LED on the B5021V Ethernet jack should turn on to indicate that the Ethernet port is alive. The yellow LED will blink to show Ethernet activity.
2. The next step is to configure the B5021V's Ethernet port for either DHCP or static IP address operation. The default setting is DHCP. You can skip to step 5 if you wish to use DHCP to set the IP address of the B5021V. Using a static IP address is recommended.
3. The “DeviceInstaller” program is used to configure the Ethernet port on the B5021V and can be downloaded from the Worth Data website. After installation the DeviceInstaller program will be located in the Lantronix folder of the Start Menu. Next run DeviceInstaller and you should see “xPico” automatically appear in the right hand window with its IP address and MAC address. If not, verify that the B5021V is powered up and connected to the same network as the host computer running DeviceInstaller.

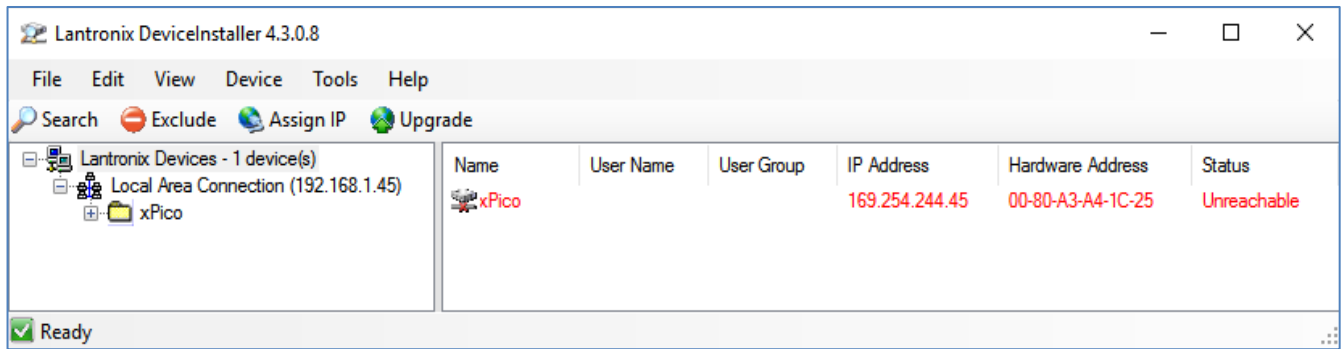

- Single click on “xPico” in the right window then “Assign IP” from the top menu bar. If more than one xPico device is listed, look for the one that starts with 169.254.xxx.xxx. The “Assign IP Address” window should open. Select “Assign a specific IP address” if you want to use a fixed IP address for the B5021V. The next screen will prompt you for the static IP address you wish to use, the subnet mask and gateway of your network. Once the IP address is configured you can close the “DeviceInstaller” program.
- A com port redirector (CPR) program is used to map a virtual com port to the B5021V. This will allow you to use any existing B5011 program with the B5021V by simply setting the com port of the host application to match the virtual com port set by the “CPR Manager” program. The CPR Manager program should be installed on the computer that is running the host program. Once installed, the host program will be able to communicate with the B5021V anywhere on the local or remote network. The CPR Manager program can be downloaded from the Worth Data website. After installation the CPR Manager program will be located in the Lantronix folder of the Start Menu.

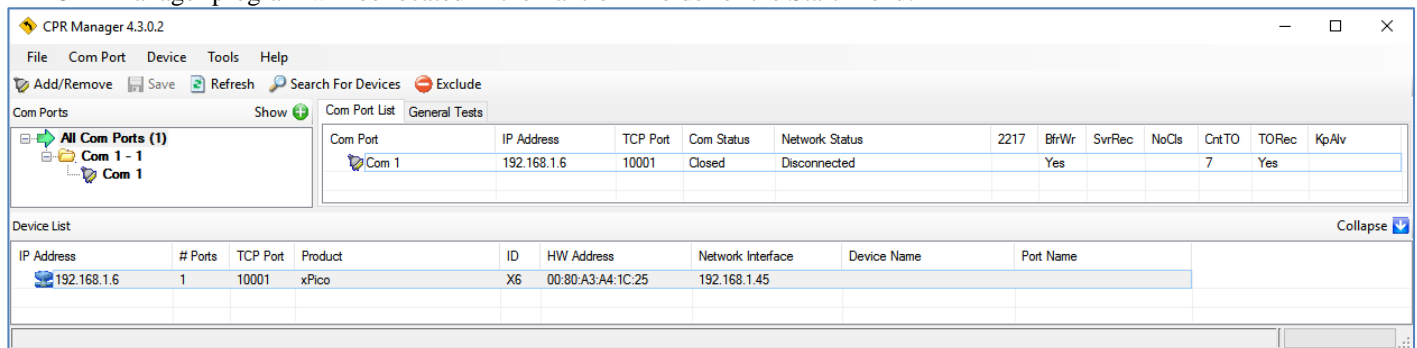

- After running DeviceInstaller to configure the IP address of the B5021V, run CPR Manager to configure the virtual COM port to be assigned to the B5021V. Click “Search for Devices” to find the attached B5021V which should then be listed at the bottom pane under “Device List”. Next click “Add/Remove” to select the virtual COM port to assign to the B5021V. Put a “check” in the box for the desired COM port then click “OK” to close the window. The selected COM port should now be listed in red in the left “Com Ports” pane and also in the “Com Port List” pane.
- Click on the new COM port in the left pane. The “Settings” pane should open on the right. The text will be in red since the settings have not yet been saved. If the “Service” & “Host” table is empty, click on the IP Address of the B5021V in the Device List in the bottom pane to add the B5021V’s IP Address to this COM port. Lastly click “Save” from the top menu bar to save the settings. The text should turn from red to black and a virtual COM port should be created with these settings. You can verify the creation of the virtual COM port by checking the Ports listed in Device Manager. The B5021V port will be listed as a “Lantronix CPR Port”.
- Since CPR Manager loads a VCP driver you will not need to run CPR Manager again unless you wish to change or remove the virtual COM ports on this computer.
- If you wish to remove the virtual COM port from this computer click “Add/Remove” then uncheck the virtual COM port assigned to the B5021V. Click “OK” to close the window then “Save” to remove the port from this computer.
- It is possible to connect more than one B5021V on the same network. Simply repeat the above procedure for each B5021V. Note that each B5021V will have a unique COM port and no relay functionality is supported. Each B5021V on the same network must be set to a different frequency using the rotary dial (SW1) on the B5021V to avoid conflicts with RF traffic. This allows overlapping coverage among 2 or more distinct host programs such as shipping and inventory.

Option #1B: B5021V Installation Procedure (B5021V on Remote Network):

The **B5021V Base Station** will first need to be configured to have a static IP address. By default, the B5021V is configured with DHCP enabled to make it easy to find the B5021V on your network. Plug in the B5021V and connect it to the local network. Run DeviceInstaller (provided by Worth Data) on a computer that is on the same network as the B5021V. Double click on the xPico in the box to the right. Then click on the “Web Configuration” tab and then the “Home” icon. A security window should open asking for User Name and Password. By default they are both blank so click “OK” to continue. Click on the “Network” tab under the

“Home” icon. Select “Use the following IP configuration” and enter the values for IP Address, Subnet Mask and Default Gateway that match the network where the B5021V will be installed. Click “OK” after entering the value. If you want to change the password of the web configuration page then select the “Server” tab and enter the password followed by “OK”. Then click “Apply Settings” to save the changes into the B5021V.

Once the B5021V has been configured it can be installed at the remote site. The router at the remote site will also need to be configured to allow the B5021V to communicate over the Internet. The router on the LAN where the B5021V is installed will need to be configured to port forward the IP port of the B5021V and the UDP ports used to communicate between the VCP driver and the B5021V. You will also need to know the IP address of the network where the B5021V is installed as viewed from the Internet. You can find this by searching for “myIPaddress” on a browser connected to the same network as the B5021V. Once you have all this information you can open the web admin page on your router (usually located on the bottom of the router) and look for the WAN settings and Port Forwarding. Here’s an example of what the ASUS router setup page looks like:

Port Forwarding List (Max Limit : 32)					
Service Name	Port Range	Local IP	Local Port	Protocol	Add / Delete
<input type="text"/>	<input type="text"/>	<input type="text"/>	<input type="text"/>	TCP ▾	
Worth Data B5021V	10001	192.168.1.130	10001	TCP	
CPR Manager	30718	192.168.1.130	30718	UDP	
CPR Manager	43282	192.168.1.130	43282	UDP	
CPR Manager	43283	192.168.1.130	43283	UDP	

Apply

In the above example, the B5021V has a static IP address of 192.168.1.130. Yours will probably be different. The other values will be the same. This completes the installation of the B5021V at the remote location.

On the computer running the host program that will communicate with the B5021V run the CPR Manager program (provided by Worth Data). Click on “Add/Remove” and select a COM port to use. This will be the COM port that the host program will communicate with. It is a virtual COM port since it will re-direct all communication over the Internet to the remote B5021V. Click on the “Com X” (X is the COM port #) on the tree in the “Com Ports” box to the left. The right box should change to show the settings for Com X. For Service #1 under “Host” enter the value of the IP Address of the B5021V as seen from the Internet. This was the IP Address that was returned by entering “myIPaddress into a search engine at the remote site. Also enter 10001 for the TCP Port. Click “Save” in the upper left corner. This will install the COM Port Redirector Virtual COM Port driver onto this computer. You should now be able to launch Hardware Utilities and talk to the remote B5021V.

Option #2: B5021R Ethernet Relay (Local Network Only)

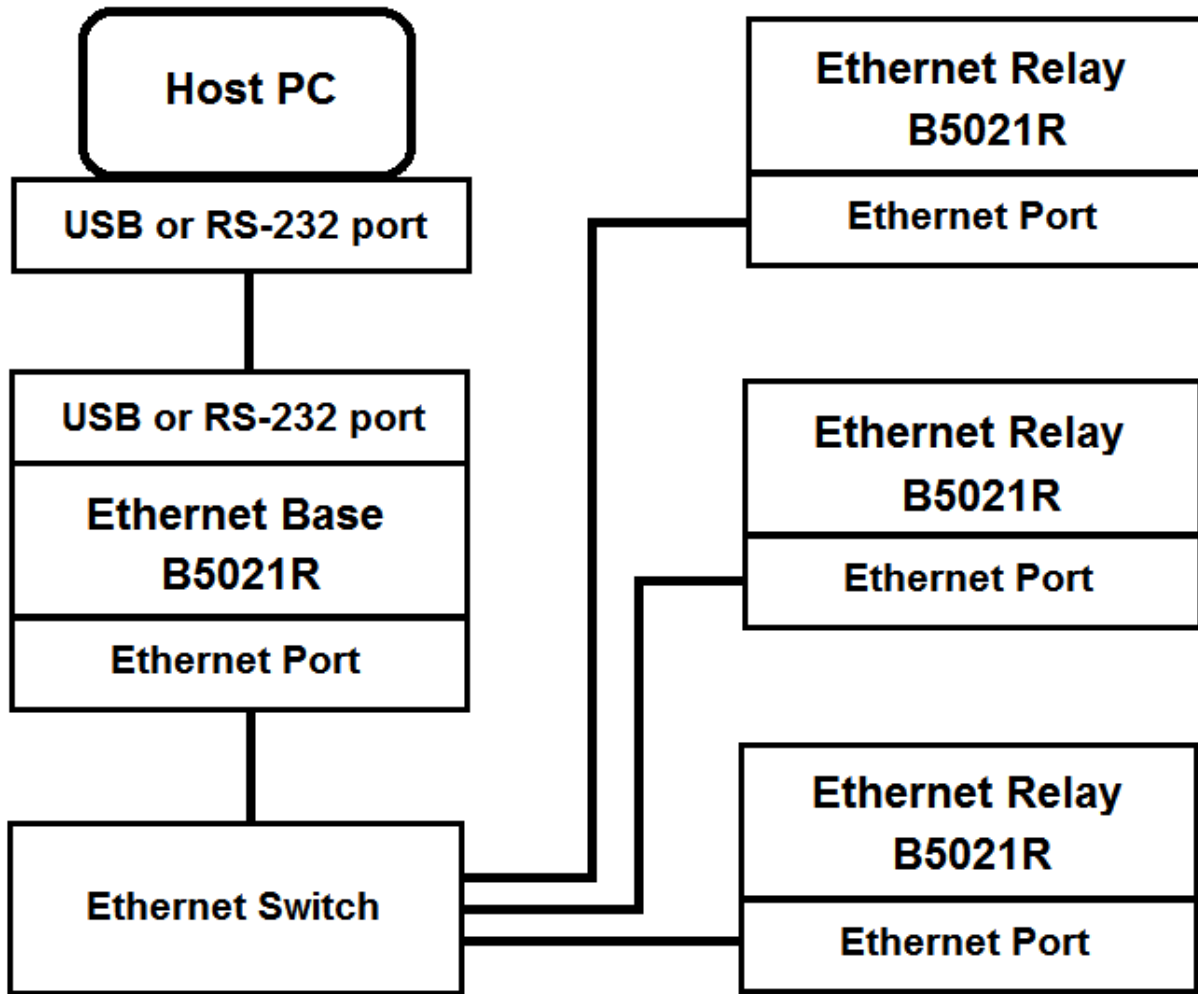

This option allows the **B5021R Ethernet Base** to manage up to 16 remote **B5021R Ethernet Relays** connected on a single network. The B5021R runs the exact same firmware as the B5011. JP13 (factory set) selects the mode for the relay (RS-422 or Ethernet) thus operation is transparent to the host application. The Ethernet Relay performs exactly like the B5011 and is compatible with B5011 host applications. Up to 16 B5021R Ethernet Relays can be connected to a single B5021R Base. Each Ethernet Relay must be set to a unique ID to differentiate it from other Ethernet Relays that communicate with the same Base. Use Hardware Utilities to set the Relay ID. See the B5011 section for further details. The RF channel(s) for the Ethernet Base and Ethernet Relay(s) can be the same or different. A jumper is used to select the desired mode of operation between either **B5021R Ethernet Base Station** or **B5021R Ethernet Relay Station**; otherwise they are exactly the same hardware and firmware.

Option #2: B5021R Installation Procedure:

The B5021R connects to the Host PC exactly the same as the B5011.

If no Ethernet Relays are installed then you can stop here. No configuration of the **B5021R Ethernet Base** is required for single base operation without relays. The steps below outline the setups required when B5021R Ethernet Relays are added to the network.

If you need to add one or more B5021R Ethernet Relay(s) to your network then you will need to do some setup on both the B5021R Base and the B5021R Relay. The first step is to set the jumpers on the B5021R Relay for proper operation. As shipped, the jumper on JP10 is installed to the left for B5021R Ethernet Base mode. This jumper must be moved to the right for B5021R Ethernet Relays. Only change this jumper on the Relays.

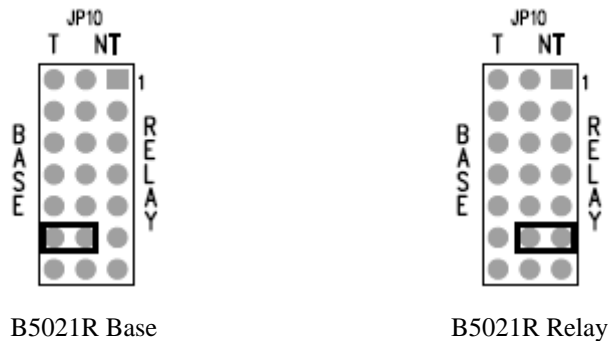

You can verify that the jumper is properly set by watching the LED on the B5021R blink when power is applied. The LED on the Base will blink green and the LED on the relay will blink orange.

The B5021R Base and B5021R Relay(s) must all be set to static IP addresses. DHCP mode operation is not allowed. There are two things to consider when choosing a static IP address for the B5021R. First, the static IP address must not overlap with the DHCP address range. Second, the static address must be unique on the local network and not overlap any other device with a static IP address. Also, the Base and Relay(s) must all be set to different static IP addresses. Consult with your network admin if you don't have this information.

To configure the IP address of your B5021R, plug in an Ethernet cable into the RELAY/NET port on the B5021R and plug the other end into a switch on the local network. Plug in the power to the B5021R if you are not using VPoE. The green and yellow LEDs on the B5021R's Ethernet port should become active.

The "DeviceInstaller" program is used to configure the Ethernet port on the B5021R and can be downloaded from the Worth Data website. After installation the DeviceInstaller program will be located in the Lantronix folder of the Start Menu. Next run DeviceInstaller and you should see "xPico" automatically appear in the right hand window with its IP address and MAC address. If not, verify that the B5021R is powered up and connected to the same network as the host computer running DeviceInstaller.

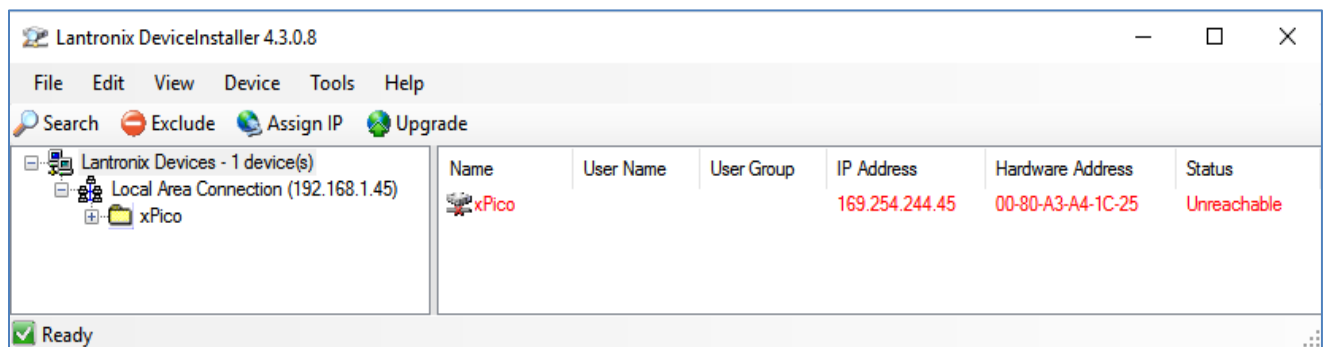

The above image shows what DeviceInstaller will look like if you do not have a DHCP server running. The xPico will default to an IP address in the 169.254.xxx.xxx range. Single click on "xPico" in the right window then "Assign IP" from the top menu bar. The "Assign IP Address" window should open. Select "Assign a specific IP address". The next screen will prompt you for the static IP address you wish to use, the subnet mask and gateway of your network. This information is available from your IT department. Once the IP address is configured you can close the "DeviceInstaller" program. Make note of the IP addresses that you assign to the Base and Relay as you will need them later.

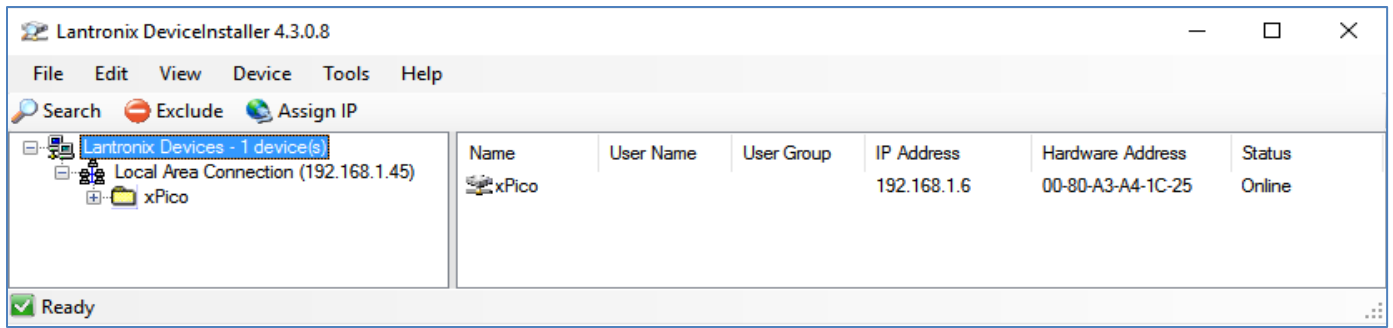

The above image shows what DeviceInstaller will look like if you have a DHCP server running. The xPico will be assigned to an IP address within the DHCP server range. Single click on “xPico” in the right window then “Assign IP” from the top menu bar. If more than one xPico is listed look for one that has not been assigned to a static IP address. All B5021Rs that are powered up and connected to the network will be listed. Make note of the IP addresses that you assign to the Base and Relay as you will need them later.

Plug in each Base and Relay(s) and repeat the above procedure until the Base and all Relay(s) are configured with static IP address. If you unplug one unit and plug in another, click on “Search” to scan for the new unit. You may want to put a tag on each Base and Relay and write its IP address on it to make it easier to do the next step. Once you have the Base and all Relays set to static IP addresses and a list of all the IP addresses you can proceed to the next step.

First, set up the B5021R Base. Plug in the Base to the network, power it up then open a browser and enter the IP address of the Base into the browser. A dialog box should open asking for a Username and Password. The default is blank for both so just click on “Log In” to proceed. The Home Page should now display. Click on “Network” on the left and the Network Setup page should appear similar to the image below:

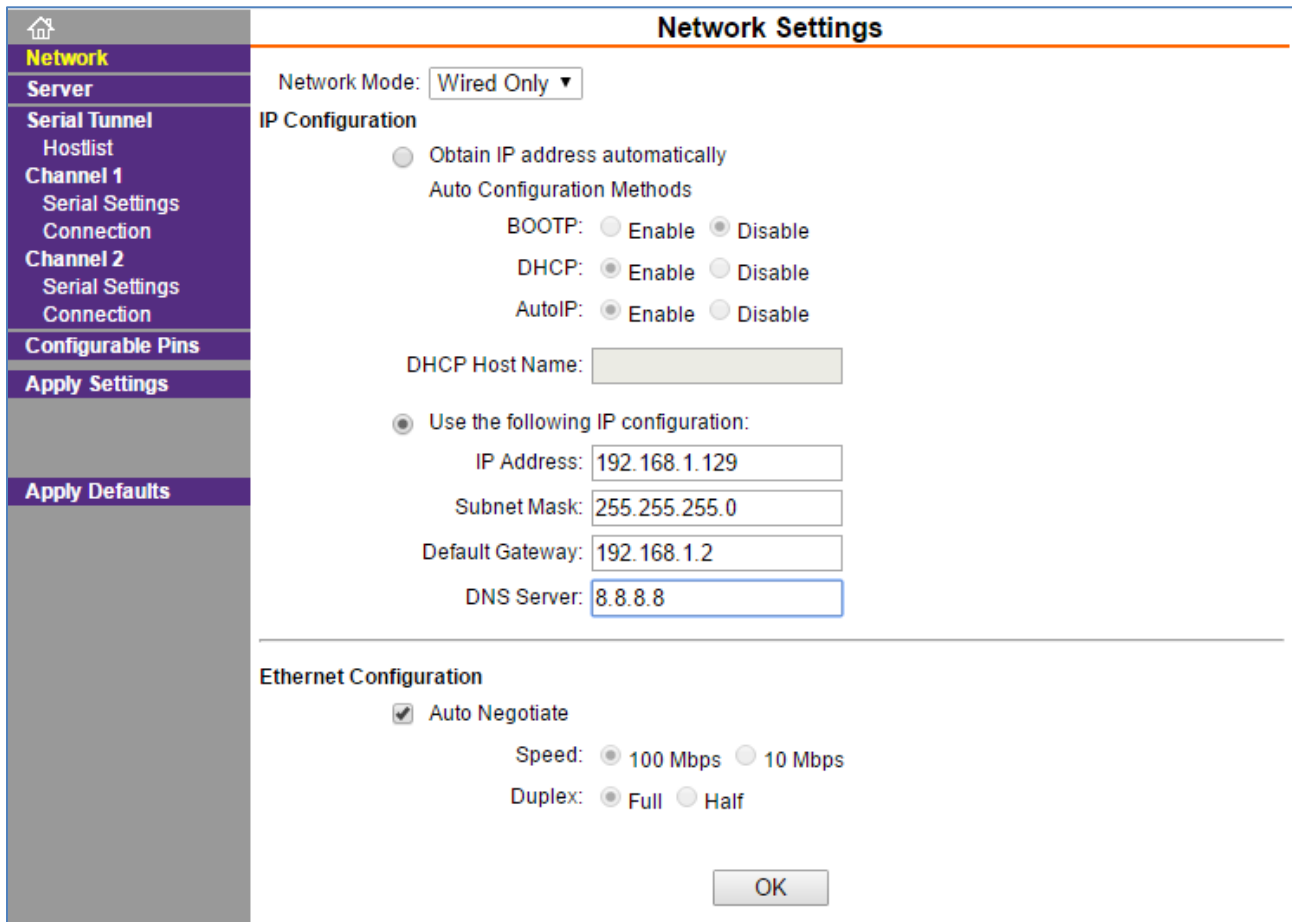

In this example the IP address of the Base is set to 192.168.1.129. Yours will probably be different but you will need to know the IP address of the Base to set up the Relays. The Gateway and DNS Server are not used for Option #2 networks since all Relays are located on the same LAN. If you change any settings click on “OK” before leaving the page to save the changes.

Next click on “Serial Settings” for Channel 1. You should see a page that looks like this:

1. Under “Port Settings” change the “Baud Rate” to 115200
2. Under “Pack Control” check the box to Enable Packing.
3. Click on “OK” to save the settings then “Apply Settings” in the box to the left to apply all saved settings.
4. Next click on “Connection” for Channel 1.
5. For “Protocol” select “UDP” from the drop down list.
6. Set “Datagram Type” to “01” in the drop down list.
7. The local and remote ports should be set to “10001” and the “Use Broadcast” box should be checked. See below:

8. You are now done configuring the B5021R Base. Click on “Apply Settings” to save all changes. The Ethernet controller will restart and the changes will take effect shortly.
9. You are now done configuring the B5021R Base. You can skip step 22 if you don’t want to change the password for the Base.
10. You can change the password for the Web Admin pages if you wish by going to the “Server” page as shown below. This is optional. After changing the password press “OK” and “Apply Settings” again.

11. Disconnect the B5021R Base and connect a B5021R Relay. Enter the IP address of the Relay into the browser. Click “Log In” to go to the home page.
12. Click on “Network” and verify that the Network settings match the Base except for the IP address.
13. Click on “Serial Settings” for Channel 1 and set the Baud Rate to 115200 and check the box to Enable Packing. Click “OK” to save the changes.
14. Click on “Connection” for Channel 1 to set up the connection to the host Base.
15. In the drop down box labeled “Protocol”, select “UDP”.
16. Set “Datagram Type” to “01”.
17. The “Local Port” and “Remote Port” should be set to “10001”.
18. Enter the IP address of the B5021R Base in the box labeled “Remote Host”.
19. Here’s an example of the Connection Settings for a B5021R Relay talking to a B5021R Base with the Base having an IP address of 192.168.1.60.

20. Click “OK” then “Apply Settings” to update the B5021R Relay with the new settings. The Ethernet controller will restart and the new settings will take effect.
21. You can enable the password on the Relay if you wish. See step 22 above. This is optional.
22. Repeat the settings for each B5021R Relay. The settings will be the same for all Relays except for the IP address of the Relay itself.
23. This completes the setup of the Base and Relay(s) for all relays located on the same LAN (Option #2).

Chapter 4: Operational Theory

Before you jump in and start writing a complex host program, it might be nice to be familiar with the theory behind the operation of your RF Terminal. The RF Terminal has three different modes of communication:

- **Two-Way Mode** - the host program transmits requests for data to the terminal via the Base Station. The RF Terminal transmits a response back to the Base Station, which in turn sends the data on to the host program. This is a truly interactive mode allowing you to create flexible programs for a variety of applications that are computer led and controlled.
- **One-Way Mode** - the RF Terminal transmits to the host with only confirmation from the Base Station. The host program receives data from the Base Station as it would any other serial device. The host cannot send data to the terminal; it can only receive information.
- **Site Survey Mode** – the Base Station and RF Terminal work together to evaluate the site and determine the best location for the Base Station. The site survey evaluates the signal strength of a number of test packets that are exchanged between the Base and Terminal. The higher the number, the more successful your communications will be from that area. This helps you to identify problem areas before you implement your RF Terminal system. At 50 ft., this is also the acid test for suspected bad radios in a base or in a terminal.

Let's start with a discussion of the basic theory behind a **Two-Way** RF Terminal system.

How the Two-Way RF System works

Basic RF System communications...

The RF system consists of three components – *Host Computer*, *Base Station* and *RF Terminal*. The *Base Station* connects to the *Host Computer* via the serial port. The application running on the *Host Computer* sends a data prompt to the com port where the *Base Station* receives it. The *Base Station* then transmits the data prompt via radio frequency to the intended *RF Terminal*. The *RF Terminal* displays the data prompt on the display and waits for the operator to enter the requested data. Once the operator enters his data, the *RF Terminal* transmits the data to the *Base Station*, which in turn passes it on to the *Host Computer*. The application on the host computer processes the information and sends a new data prompt out to the *Base Station* and the whole process begins again.

A little more in depth...

This RF system's dialogue is Terminal initiated. The Terminal says, "I'm here, give me something to do. The Worth Data RF system is different from other systems in that our RF Terminal does not constantly "listen" for a data prompt from the host. We decided to use a different approach that would help to eliminate unnecessary radio traffic, conserve battery power, reduce the size of the Terminal, and greatly simplify the operation.

Here is how it works:

Each RF Terminal has a unique **Terminal ID**. When the RF Terminal powers up, it asks if you want to **1. - SIGN ON** Pressing 1 Key causes the RF Terminal to transmit it's **Terminal ID** and a byte of data indicating to the Base Station that it wants to sign on to the system.

When you press the 1 key to **SIGN ON**, the RF Terminal will start communicating with the Base Station, if there is a delay connecting, you may see the following message:

**Waiting Prompt from Host
Computer: F1:Exit; F2:Help**

This message is normal when first establishing communication and may occur occasionally during normal operation during processing delays.

When the Base Station receives a **SIGN ON** message from a RF Terminal, the Base Station transmits the SIGN ON information to the host computer. The host computer application can then do one of two things:

- If it has something for the Terminal to do, it can send a prompt to the Base, which in turn transmits it to the Terminal. The RF Terminal receives the prompt, waits for the operator to enter the requested data, and then transmits the data back to the Base Station.
- If the host program does nothing within an allotted time, the Terminal displays the message:

Waiting Prompt from Host Computer: F1:Exit; F2:Help

Lets suppose that a RF Terminal and a Base Station have been processing data by sending prompts and data back and forth as described in example 1. The Base Station sends a data prompt to the RF Terminal, the RF Terminal transmits the operator-entered data back to the Base Station. If the host program has another prompt for the terminal, the Base sends it out, repeating the process above.

Suppose the host program does *not* have a prompt ready to send back to the Terminal; the Terminal transmits its data to the Base Station but does not receive a new data prompt. The Terminal then retransmits its data (it thinks maybe the host didn't receive it) and waits for a response.

Once the terminal has received a prompt back from the host, the time it took the host to respond is sent to the Terminal. For all subsequent transmissions, the terminal goes to sleep until the time it took the last time for the host to respond has expired; then the terminal wakes up and listens. If it has nothing, it retransmits its data and waits for a response.

The original data transmission could have collided with another message, or the Base could have received the Terminal's data but had not yet received the host's prompt response. If the previous transmission got through, the Base Station knows that the data is a retransmission rather than a new data transmission so it sends a message to the Terminal telling it:

"I have nothing for you from the host, go to sleep".

While in "sleep" mode, the Terminal "wakes" up at a random interval and asks "do you have anything for me yet", waiting for either a "go to sleep" message or a new data prompt. After each delay, the Terminal displays:

Waiting Prompt from Host Computer: F1:Exit; F2:Help

If a Terminal receives *no* response at all from a Base Station (no data prompt or "go to sleep" message), it retransmits its data and waits for a response. If the Terminal gets no response after 10 re-transmissions, it assumes it is out of range from the Base Station with which it was communicating, and attempts to establish contact with any Base Station. If the Terminal can't contact any Base Station, it displays:

Transmission Failed. ENTER to Retry: F1:Exit; F2:Help

Pressing the ENTER key on the RF Terminal starts the re-transmission process over again. The RF Terminal will try to retransmit its data, displaying the TRANSMISSION FAILED message after every 10 unsuccessful tries.

Can I change a prompt after it has been sent?

Normally once the Terminal has received a prompt from the host, it goes to sleep and waits (as long as it takes) for the operator to scan or key something in response. The host cannot send another prompt without creating a "Sequence Error." You might want to change the prompt or locate a lost terminal with beeping.

There is a special setting in the RF Terminal Setup in which you specify the time (between 5 seconds and 7 minutes) you want the Terminal to quit waiting for input from the operator, blank the screen, send back a special control character to the host program, display "Waiting on Host Prompt" and wait for a prompt from the host application program; the host application program can choose to send back different instructions or simply repeat the previous prompt's instructions, (See [Automatic Check Back](#) in the *Programming Section*).

How One-Way Mode works

The RF System can be used to perform "simple" data entry to the computer. This is useful if you want to enter data directly into an application. This type of data transmission is called **One-Way Mode**. You can find this tool in the **System Tools** in the **SETTINGS MENU**.

Once the RF Terminal transmits data to the Base Station, the Base Station acknowledges receipt of the information by echoing back the data to the Terminal that sent it, along with a beep. If the data transmission *did not* make it through to the Base station after 10 tries, the RF Terminal will give two long beeps and display the following message:

Transmission Failed. ENTER to Retry: F1:Exit; F2:Help

One-Way mode also works well as a test program since it doesn't require a program running on the host computer or even that the Base Station be connected to the host. To get into **One-Way Mode** select option 9 from the SYSTEMS TOOLS mode. **One-Way Mode** is run from that menu option

If the Base Station already has other RF Terminals signed on in Two-Way mode, you will not be allowed into the system. A Base Station must be dedicated to one mode at a time.

If the Base Station is dedicated to One-Way mode, you will see the following prompt on the RF Terminal display:

Data Received Was

Enter Data?

Since you have just started your One-Way session, there is no data to display on line #2. Line #3 is now asking you to scan or key data into the RF Terminal. If you are entering data from the RF Terminal keypad, you must press the ENTER key to transmit your data. If the Base Station receives the data, the RF Terminal displays the following prompt:

Data Received Was

aaaaaaaaaaaaaaaaaaaa

Enter Data?

Where **aaaaaaaaaaaaaaaaaaaa** is the data received by the Base Station (and transmitted to the Host Computer if connected). You can exit One-Way Mode simply by pressing the F1 key on the RF Terminal keypad.

In One-Way Mode, the RF Terminal transmits its **Terminal ID** to the Base Station but it **does not** pass it on to the Host Computer. If your application on the Host Computer needs to know which RF Terminal data came from, use the **Preamble** setup parameter to enter unique identifying information. Data is also transmitted *without a Terminator Character* (like a CR or TAB that is transmitted after the data); so if you need one, use the **Postamble** setup parameter to add the appropriate character(s) after your data. For more information on *Preambles* and *Postambles* see **Chapter 2; RF System Setup** for details.

How Site Survey works

The RF Terminal uses **Site Survey** mode to: 1) test the radios at short range, (50 ft.) as an acid test for correct operation, and 2) to evaluate a specific site for effective coverage. Because each operating environment is different, it is almost impossible to predict the range without **Site Survey**.

Before you permanently install any hardware, you should perform a Site Survey to fully evaluate your planned area of operation. During the test the RF Terminal is transmitting messages and waiting for acknowledgment from the Base Station. (Since this US Terminal hops over 26 different frequencies, the Site Survey goes across all frequencies to make comparisons valid; this takes about 5 seconds.). The Site Survey mode displays the success rate of sending 50 packets to the Base. The higher the number, the more successful your communications will be from that area.

Site Survey does not require your Base Station be attached to your Host Computer. All you need is your Base Station, a Worth Data 5V power supply, and RF Terminal. If you only have a USB cable for connection, you will need to connect the base up to your computer to power up the base. For detailed information on how to perform a Site Test and use the results to determine the best location for your Base Station, go to [Chapter 5; Site Tests](#).

Chapter 5: Site Tests

Evaluating your area of planned operation

Since every operational environment is different, it is impossible for us to tell you exactly what equipment you need and where you should put it to achieve maximum performance from your RF System. However, with 3.3 miles of open area range, unless you are going through a lot of walls, you probably won't care where the Base is located and you probably will not need a Relay.

The simple built in Site Tests were developed so that the user could start with a minimum system (RF Terminal and Base Station) and determine for themselves what their realistic operating range is, what additional equipment they need, and where to install their Base Stations to achieve optimum performance. Some other manufactures require expensive Site Surveys before you can even purchase any equipment from them. Our Site Survey allows you the flexibility to Site Survey whenever you choose, whether it is before you install your system or during operation to troubleshoot RF problems. The Site Tests are the most valuable tool you have to help you achieve an efficient RF System with maximum range.

There is also some basic information about Radio Frequency itself that can help you make smart choices about the location and composition of your system:

- **Metal walls are almost impenetrable by RF.** If your warehouse computer is located in a metal shed, don't locate the Base Station inside with the computer. Locate the Base Station outside the metal shed instead.
- **The more walls you try to transmit through, the more the signal breaks down.** Walls that have metal studs (interior office walls) and concrete walls with steel rebar slightly degrade the signal with each wall you try to go through. Metal walls may require the use of Relay Stations to achieve adequate coverage.
- **Organic material absorbs RF energy.** If you are trying to operate in an area with lots of densely packed organic material (bags of beans or corn), expect and plan for reduced operating ranges.

There are some additional measures (other than a Site Test) you can take early on to maximize your range:

- **Base Stations should be located at the center of the area of intended coverage.** If they are not located in the center, they should be tilted in the direction of use.
- **Raise the Base Station.** Sometimes just raising the Base Station a foot or two will dramatically increase your operating range, especially in a warehouse or grocery store environment. Mounting the Base Station on the ceiling with the antenna pointing down is the best. USB connections to the B5011 limit the height you can easily raise up the B5011 Base Station, so you might consider a B5021R or using the B5011 with a long DB9 serial cable.

Performing a Site Survey

As we have said before, the Site Survey is your most valuable tool for evaluating your planned area of operation. All you need to perform a Site Test is a RF Terminal, a Base Station – The Base Needs to be powered up via USB, or with a Worth Data F10 5V power supply. There are a few things you need to do though before you begin:

- Make sure **all other** Base Stations and Relay Stations on the same RF channel are turned **OFF** – Only Test with 1 RF Terminal at a time.
- Make sure that the Base Station and RF Terminal you are using are set to the **same RF Channel**. Base Stations and RF Terminals are shipped from the factory set to channel 0. If you need to change the Base channel, see [Chapter 3: Base Station Configuration](#).

The Base Station does not need to be connected to a host computer to do a Site Survey – if you have a Worth Data F10 Power Supply you can power it with that power supply. If you are powering the Base Station by USB, then you will need to connect to your computer to power it up, or use a USB power adapter – The F17 power supply for the Base can be used with the C21 USB cable. Locate the Base where you think you will have the best range and power it up. Turn on the RF Terminal:

Site Survey is now located in the **SYSTEM TOOLS** sub menu. Select option 2 on the Opening Screen for **SETTINGS**, then **SYSTEM TOOLS**, then select **7** for *Single Site Test*, or **8** for the *Continuous Site Test*.

Single Site Test Mode

With the Base Station powered up, walk to the area where you want to perform your first test – a good starting point is around 50 ft. away from the Base. When in position, stop and look at the RF Terminal display. It should read:



Single Site Test Mode
Press Enter When Ready
or F1 to Exit

Press the ENTER key to start the Single Test mode. During the test (about 4-5 seconds), you can move around, but for the single test its best to stay in one location to get a good reference. During the test the RF Terminal is transmitting many messages and waiting for acknowledgement from the Base Station. During the test the following message displays on the RF Terminal screen:

Site Testing in Progress,
Please Wait.....

Please Wait... will display on your screen until the test is finished. If it takes more than a few seconds, there is something wrong. When the test is finished, you will see the results displayed in the following format:

Test Result: xxx%
RSSI Value: -xxdBm
Press Enter – Single Test
or F2 – Continuous Test
or F1 to Exit

Continuous Site Test Mode

With the Base Station powered up, walk to the area where you want to start your testing. When in position, stop and look at the RF Terminal display. It should read:



Continuous Site Test Mode
Press Enter When Ready
or F1 to Exit

Press the ENTER key to start the Continuous Test mode. During this test you can move around and see the site test values. During the test the following message displays on the RF Terminal screen:

Running Continuous Test
Press F1 to Exit.

During the test (each one takes around about 4-5 seconds), you can move around and see real-time results to help you see where you may have poor coverage. The values will show the percent of good transmission, and dBm levels, as you move around until the F1 is pressed:

Test Result: xxx%
RSSI Value: -xxdBm
Running Continuous Test
Press F1 to Exit

The result shows the percent of successful transmissions. As long as you are getting at least 80-90%, you will have excellent results in the location tested. You can still get decent performance with results around 50% but there will be some slight delays due to re-transmissions. If you don't get the minimum results shown above:

1. Try hanging the Base Station upside down or tilted toward the area of usage – this alone can double the effective range.
2. Try locating the Base Station closer to the area of difficulty. Remember that moving the Base Station will require you to recheck the other locations already tested.
3. If none of the above works, you will have to consider using a Relay.
4. If you are getting 0% then the Radios are not on the **same RF Channel** or you have a bad radio in one of your units.

Chapter 6: *Programming*

Before you begin programming...

The RF Terminal operates in two basic ways:

Two-Way communication, where messages from the host user program are sent to the Base Station (via the serial port), then from the Base Station to the RF Terminal. The Terminal responds back to the Base with data and its Terminal ID. The data is then transmitted from the Base to the host computer where it is processed and the next command is sent out. Each RF Terminal has a unique Terminal ID, allowing a single Base Station to handle up to 64 Terminals.

Two-way dialog is established when a Terminal SIGNS ON to the RF network. The host computer application waits until a Terminal SIGNS ON, then begins its processing by sending the first prompt out to the Terminal via the Base Station. If the Terminal does not receive a prompt from the host, it goes into “sleep” mode, “waking up” and checking with the Base periodically (see **Chapter 3; Operational Theory** for details) to see if it has any messages waiting. This conserves battery power and reduces radio traffic.

Two-Way mode requires programming to communicate with the Terminal where One-Way mode does not. We have tried to make it easy for the programmer to communicate with the Base Station; no protocol or handshaking is required. This type of communication is fine when the Base is located only a few feet from the serial port it is connected to. If you are locating your Base Station farther away, use shielded, grounded (bare wire Pin 1 touching shield) cable, lower baud rates and possibly, line drivers for very noisy environments. (Do not use Cat 5 wire for a serial cable).

Before you begin programming, there are some factors you should take into consideration during the planning process.

- **Plan for system failures.** This includes hardware failures, software failures and operator failures. In order to create an efficient application, you must put some thought into what you will do when different parts of the system fail.
- **Look for All Errors.** Be sure your program is trapping all possible error conditions that the Base Station may return to you. The list includes:

Sequence Errors detected
Illegal Command detected
Base Station Initialized
Addressing a Terminal Not Signed In
Command without an ID

All of these error conditions are detailed in the next chapter. Don't forget to program for them; this is a common mistake. Failure to trap them will give create very strange, unpredictable results.

Even though you don't think your code will ever make a mistake, take advantage of feedback that the Base Station provides. Failure to do so is a common mistake that eventually results in serious program failure, sometimes due to hardware problems that go undetected.

- **Parse the Returned Strings thoroughly.** Don't assume anything about the next response from the Base to your program and look only for the partial string such as the ID only; parse the string returned completely and be sure you are examining every possibility. Failure to do so is a common mistake.
- **Plan for expansion.** You may start small (1 base/1 Terminal) but try to create an application that will allow for easy expansion and addition - especially of Terminals.
- **Use the Demo Programs.** The demo programs can at least allow you to see how the system functions and whether you can anticipate any system-wide problems. The demo programs should also be used as a response-time benchmark.

One-Way communication, where all data transfer is initiated by the RF Terminal. This is not very useful, because it has no editing or prompting. The Base Station itself simply acknowledges the receipt of the data by echoing it back to the Terminal. The host computer has no dialog whatsoever with the Base Station or Terminal; it is simply used to take the data coming from the Base through the serial port and do something with it.

Failure Planning

Hardware Failures

Let's assume that each part of the system has failed. How are you going to know what has happened and how are you going to recover?

- The most frequent failures are at the Terminal level. If a Terminal has a hardware failure, it will not be able to SIGN OUT. It is possible for the Terminal operator to press the ON/OFF key or the F1 key by accident, forcing the Terminal to SIGN OUT - sometimes in the middle of a transaction. This happens at battery-charging time also. You need to plan for partial transactions - do you trash the data you do have and start over, or pick up where you left off?
- Keep in mind that if a Terminal has SIGNED OUT in mid-transaction, the Base Station clears any pending message for that Terminal before it will allow it to SIGN ON again. Make allowances to re-send messages or prompts that were cleared upon SIGN ON if necessary.
- If a Base Station has a hardware failure, neither the Terminal nor the host computer will be able to communicate with it. When the Base Station comes back on-line, it sends a "Base Station Initialized" message back to the host, letting the host know that it must re-initialize all Terminals and pick up any incomplete transactions.

Operator Errors

- Plan on your operator walking out of range and going to lunch in the middle of a transaction. What do you do with the data you do have, and where are you going to start up again?
- Let's say your operator is SIGNED ON and decides it's time to take a break. Instead of pressing the F1 key to SIGN OUT, he presses the OFF key. Pressing the OFF key is OK (it will SIGN him OUT) but there is a delay until the SIGN OUT is acknowledged. Because of the delay, the operator might think he didn't press the key hard enough and press it again - this time actually powering down the Terminal *before* the SIGN OUT was complete. If this happens, you need to plan to *re-send* the last prompt to the Terminal when he SIGNs ON again.

Programming for the RF Terminal

The three levels of programming support offered for the RF Terminal are:

- Low Level ASCII sequences sent to and from the Base Station by the user program reading/writing to the serial port.
- .NET and ActiveX drop-in components. Every necessary function is defined. You just complete the code for each function.

Low-Level Direct to Serial Port Programming

Planning

Remember, plan for every error that the Base Station might return including:

Sequence Errors detected
Illegal Command detected
Base Station Initialization detected
Addressing a Terminal Not Signed In detected
Command without an ID

Programs can be written in any language that has access to the serial port (reading/writing), regardless of the platform. No more than one Base Station is allowed for each serial port.

Host to Terminal Programming

The basic format of a message that is transmitted from Host to Base to Terminal is fairly simple:

Byte position	Function	Possible values
1	RF Terminal ID	0-9, A-Z, a-z, - =
2+	Command(s)	**
Last	Termination of message	EOT (ASCII 4)

The **RF Terminal ID** is always the first byte and always only 1 character in length. There are 64 different possible values - 0-9 , A-Z, a-z, - and =.

The **Command(s)** section of the message always starts with the second byte and can consist of one or more commands - including data to be displayed or voice messages to be broadcast. The maximum number of total bytes that can be sent in one command is 500 including all overhead and control characters.

The last byte is always ASCII 4 (**EOT**) to terminate the message.

Here is a listing of valid commands and examples:

Command characters	Command function
*@	Reinitializes the Base Station , all terminals must cycle power and sign in again
3@	Reinitializes Terminal #3
1@Bn	Make Terminal #1 beep n (1-9) times
2@C0 *	Clears the entire screen (4, 6 or 15 lines) on Terminal #2. *See more about 4 and 6 line displays on page 6-4.
0@C1	Clears line 1 on Terminal #0
1@C2	Clears line 2 on Terminal #1
2@C3	Clears line 3 on Terminal #2
0@C4	Clears line 4 on Terminal #0
3@C5 *	Clears line 5 on Terminal#3 (if 6 line display), Clears all lines if 4 line display. *See more about the two display types on page 6-4.
1@C6 *	Clears line 6 on a 6 line display. Will do nothing on a 4 line display. *See more about 4 and 6 line displays on page 6-4.
1@C7- 1@CF	Clears lines 7 through 15 on a 15 line display. Will do nothing on a 4 or 6 line display. *See more about 4 and 6 line displays on page 6-4.
1@CX	Clears screen (same as @C0) and sets SMALL font, 15 lines with 26 characters per line
1@CY	Clears screen (same as @C0) and sets MEDIUM font, 10 lines with 20 characters per line
1@CZ	Clears screen (same as @C0) and sets LARGE font, 7 lines with 13 characters per line
1@Dn	Displays date and time on line n (1-4) in US (mm/dd/yy, hh:mm:ss) or Euro (dd/mm/yy, hh:mm:ss) format on Terminal #1
1@Vnn	Play voice message #nn (01-99) on Terminal #1
1@Sdataxxx	Output <i>dataxxxxxx</i> to serial port on Terminal #1 -max 231 chars

NOTE: The 15-line terminal defaults to small font on Sign-In.

Color Display Programming

New commands have been added to take advantage of the larger color display on the 7000 RF Terminals. You now have the ability to define the color and font size on a line by line basis.

There are 16 possible text and background colors available to choose from. They are the same 16 colors used in HTML programming.

The @C command has been expanded to set the foreground and background colors for the entire display and within the same command you can also set the font size for the entire display to all be the same or split up the display using different size fonts for each line.

The command structure is as follows:

@C[fnfnfn...][\cb]

Where:

@C are the 2 header bytes

f: is the font size and can be either S, M or L for small, medium or large

n: is the number of lines being defined

\cb: defines the user default colors, c=text color, b=background color

The \cb command can also change the active text/background color within a prompt at any time.

All screen formatting and color commands are dynamic and not stored in the unit so they will need to be sent at every sign-in. The color codes are:

0 = AQUA	1 = BLACK	2 = BLUE	3 = FUCHSIA
4 = GRAY	5 = GREEN	6 = LIME	7 = MAROON
8 = NAVY	9 = OLIVE	A = PURPLE	B = RED
C = SILVER	D = TEAL	E = WHITE	F = YELLOW

Here are some examples:

@CS2M2L2

will clear the screen and set the first two lines of the screen to be small fonts, the next two lines to be medium fonts, and the next two lines to be large fonts. The remaining undefined lines will be small font with the default colors. The default colors will be used since there is no \cb at the end of the command.

followed by:

@1,1,0,\BEWarning@3,1,0,\2IInvalid Data@5,1,1,\ACData<EOT>

will display "Warning" on the first line in small font with RED text on a WHITE background, "Invalid Data" on the third line in medium font with BLUE text on a BLACK background and "Data" on the 5th line in large font with PURPLE text on a SILVER background. The cursor will be positioned after the "Data" on the 5th line and entered text will be in the last color combination, PURPLE on SILVER.

Remember that if you only define 6 lines then the remaining lines on the screen will be defined as small font with the default colors.

When you are defining the font size for each line of the screen be aware that the total pixel count of all the lines defined cannot exceed the height of the screen.

The total height of the screen is 240 pixels. A small font is 16 pixels tall, a medium font is 24 pixels tall and a large font is 32 pixels tall.

If you define 2 lines with small fonts, 2 lines with medium fonts and 2 lines with large fonts you will be using $(2 \times 16) + (2 \times 24) + (2 \times 32) = 144$ pixels out of a maximum of 240 pixels. The top 144 pixels of the display will be used, the bottom 96 pixels will be divided into 6 lines $(96/16=6)$ of small font..

If you attempt to define a combination of fonts that exceeds 240 pixels total, a ? will be returned to the host for invalid command.

Here are some more examples:

@C\E1

will clear the screen and set the default colors to WHITE text on a BLACK background. In concept, @C\E1 is the same as @C0\E1; however, @C0\E1 is an invalid command. The change of user colors is always embedded in a Clear Screen Command.

@CS1M3L1S1L2\BE

will clear the screen and set the first line to be small font, the next 3 lines to be medium font, the next line to be large font, the next line to be small font and the last two lines to be large font with RED text on a WHITE background for all lines. The total height of the lines will be $(1 \times 16) + (3 \times 24) + (1 \times 32) + (1 \times 16) + (2 \times 32) = 200$ pixels:

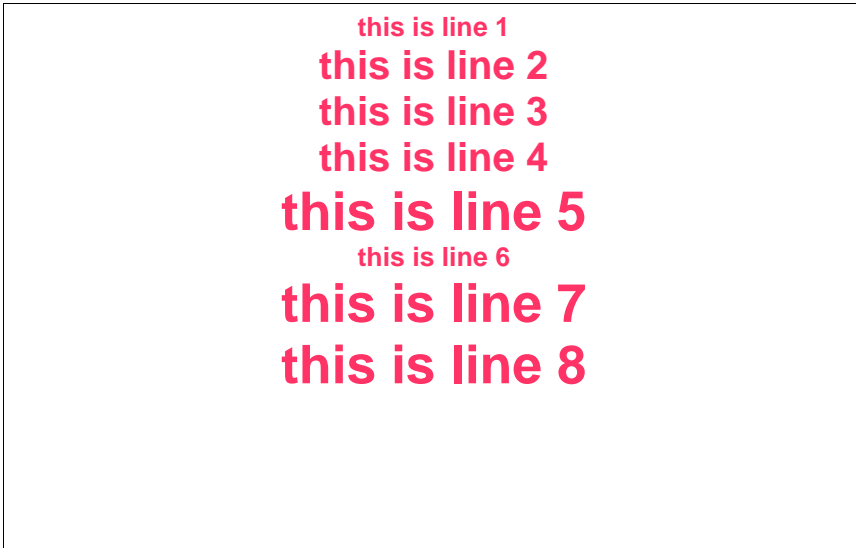

The active colors change whenever \cb is received in a prompt. The user default will be used to display all the prompts unless \cb changes the colors. All prompts will start with the user default. The active colors from the last prompt will NOT be carried over to the next prompt.

A typical “prompt” command sequence follows the format below:

0@n,m,o,data

<i>where</i>	<i>n</i>	is the line number (1-15) you want the prompt displayed on 1-9 for lines 1 thru 9, and A-F for lines 10-15
	<i>m</i>	is the character position (1-20) where you want the prompt displayed
	<i>o</i>	is the character that determines whether the prompt is for display only (0) or is waiting for data input (1) See the table below for valid characters for this position.
	<i>data</i>	is the data you want displayed

For example, the command **@1,1,1, Enter Quantity** would display **Enter Quantity** starting at position 1 on line 1, then wait for the operator to enter their data.

These are valid entries for the third position character:

0	No data input for this Command, Display ONLY
1	Data input required from the keypad or scanner
2	Only keypad input allowed, start un-shifted
3	Only keypad input allowed, start SHIFTED
4	Only scanner input allowed
5	Only accept YES (Enter key or C key) or NO (0 key or B key) keypad response. (Terminal sends 1 for YES, 0 for NO). C and B key are there to facilitate YES/NO keypad entry while scanning with integrated laser.
7	Single key entry required. Only one keystroke is accepted with the following exceptions: F2 – replays last voice prompt, DELETE and CLEAR are ignored, STATUS – displays status, SHIFT – toggles shift mode as usual, ENTER – transmits an empty string, F1 – exits.
A	same as 1, but time stamped as prefix (hhmmss)
B	same as 2, but time stamped as prefix (hhmmss)
C	same as 3, but time stamped
D	same as 4, but time stamped
E	same as 4, but can press END key to break-out of scanner-only input mode. Terminal ID + CR is sent to host
S	SHIFTED keypad input or scanner input
p	un-shifted keypad entry with no display (for passwords)
P	SHIFTED keypad entry with no display (for passwords)

Here are some rules and useful tips for creating messages (one or more commands per message):

- Re-initialize commands ***@**, or **n@** (where **n** is the Terminal ID 0-F) clear the buffer for terminal(s) in the Base Station. Following a re-initialization, the host program should re-display of all the screen data necessary to start the application.
- A message with multiple commands is legal and useful. For example, the command “@1,1,0, PLEASE ENTER@2,1,1,QTY” would display PLEASE ENTER on line 1, display QTY on line 2, and then wait for data input. All 15 lines can be filled with one message.
- Messages can be a combination of multiple commands, (i.e. voice messages, initialization, clearing lines, requesting data entry), up to 500 characters in length. A message cannot though, contain an @S command in combination with any other command. A message also **should not** contain more than 1 request for data entry (third character in command is **1**). For example:

@1,1,1,ITEM@2,1,,QTY

has two data entry “prompt” commands combined. If this message were sent to the RF Terminal, the first data entry prompt (**@1,1,1,ITEM**) would be executed, but any and all commands after the first data entry prompt in that statement would be ignored without warning – there will be no display or indication of an illegal command.

The **@S** command (for “serial” wireless printer output) statement **cannot** be combined with any other command - even clear (**@Cx**) commands. After a **@S** command is successfully completed, the Base Station sends back to the host the RF Terminal ID followed by a CR (ASCII 13). *There is a 231 character limit on data for this command.* If you send a command of more than 231 characters, you will get an Illegal Command returned, (ID ? CR). If you need to send 300 characters of data, send the first part, wait for the acknowledgement (ID CR), and then send the remaining part. If you are using the **@S** command with a printer *other* than the Zebra QLx or ZQn series, you may need to do some special programming to allow the RF Terminal to deal with the character buffer limitations of your particular printer. See your printer manual for details.

- Every statement must end with a data entry “prompt” command, whether the statement is a single command by itself or several commands combined together. Any illegal command will be ignored as a command but will be displayed on the addressed RF Terminal as a “?”. If no Terminal ID was included in the statement, it will try to display the invalid statement on ID 0. Once the ENTER key is pressed on the Terminal displaying the invalid statement, the terminal sends the Base Station a “?” character. The Base Station then in turn sends the message **n?CR** (where **n** is the Terminal ID and CR is a carriage return) back to the Host computer.

- The “Clear lines” command (@Cx) for the 15 line displays differ slightly from the “Clear lines” command for the legacy Gen 1 4 line and the Gen 2 6 line displays.
- The following table shows the programming differences for 4 lines/6 lines:

Command	4 Line	6 Line	15 Line
@C0	Clears all lines	Clears all lines	Clears all lines
@C5	Clears all lines	Clears line 5	Clears line 5
@C6	No effect	Clears line 6	Clears line 6
@CA	No effect	No effect	Clears line 10

- In order to maintain compatibility with GEN 1 4 line display terminals and GEN 2 6 Line display terminals, in an existing system, there is option in the RF Terminal Setup – LCD SETTINGS – **4/6 LINE LEGACY MODE** that allows the user to configure the RF Terminal as a 6 line display terminal or as a 4 line display (centering the data on the display and conforming to the old programming command format, i.e. @C05 clears all lines).
- The SIGN ON character for a unit set for LEGACY MODE 6 line display (see the previous point concerning LCD DISPLAY MODE) is different than for a LEGACY MODE 4 Line display. A unit set as a 6 line display terminal signs on using ASCII 22, a unit set for 4 line display signs on using ASCII 15.
- The error message **WAITING HOST PROMPT** may occur if the software is not designed to work with a 15 Line LCD.

CAUTION: All 7000 Series RF Terminals are 15 line display terminals by default, they can be configured as 6 line display terminals and SIGN ON using ASCII 22. If you are trying to SIGN ON to an existing 4 line display terminal system that has not had any changes in its programming to utilize the 15 line LCD, or you are set to 6 line legacy mode, you will NOT BE ABLE TO SIGN ON. Make sure to reconfigure the Terminal using the LCD LEGACY MODE to operate as a 4 line display terminal.

Here are some sample command statements utilizing some of the programming tips offered above:

@2,1,1,ENTER ITEM NO	Display ENTER ITEM NO on line 2, position 1 and wait for data input. This is a valid single command statement – it ends with a data entry request.
@V23@1,2,1,WRONG ITEM	Play voice message 23, display WRONG ITEM on line1, position 2 and wait for data input. This is a valid multiple command statement – it ends with a data entry request.
@C1@1,7,0,PICKING	Clear line 1. Display PICKING at position 7 of line 1. This statement is illegal . To be a valid statement, it must end with a data entry request. For example: @C1@1,7,0,PICKING@2,7,1,ITEM
@1,1,1,ITEM@2,1,1,QTY	Since only one command can be a “prompt” data entry request, this is an illegal statement and would be ignored as a command. It would be valid if changed to @1,1,0,ITEM@2,1,1,QTY

Base Station to Host Formats

The basic format of a message that is transmitted from Base to Host is fairly simple:

Byte position	Function	Possible values
1	RF Terminal ID	0-9, A-Z, a-z, - =
2+	Data Transmitted	**
Last	Termination of message	CR (ASCII 13)

Typically, the Base Station is sending the “answer” to the hosts “question” - for example, if a Base sent a host message to a terminal #2 that said:

2@1,1,1,ITEM NUMBER + EOT

The RF Terminal would display ITEM NUMBER on line 1, position 1 and accordingly, the operator would then enter an item number by scanning or using the keypad. The RF Terminal transmits the data entered -say it's **123** - to the Base Station, which in turn transmits the following to the host:

2123+CR

Where **2** is the Terminal ID, **123** is the data and **CR** is the termination, (the plus sign is not transmitted). Besides data, there are other messages that the Base Station will send to the Host:

Serial Reply

After a **Serial** command (**@S**) has been successfully completed, the Base Station sends to the Host the Terminal ID followed by a CR. Serial commands are typically used for portable wireless printers. Serial commands cannot be combined with other commands in a message to the Base Station/Terminal. Remember, you can only send 231 characters (including the ID + @S + EOT).

SIGN ON

To login to the host computer, the user presses a key on the RF Terminal at power-up to get to the SIGN ON screen. As the user SIGNS ON, the Base Station sends back the following SIGN ON message to the host:

Byte position	Function	Possible values
1	RF Terminal ID	0-9, A-Z, a-z, - =
2+	SIGN ON	SYN (ASCII 22) if 15 line display configured as a 6 line display.
		SI (ASCII 15) if 15 line display terminal configured as 4 line display.
		DC4 (ASCII 20) if 15 line display configured as a 15 line display.
Last	Termination of message	CR (ASCII 13)

After a terminal SIGNS ON, the host should be prepared to acknowledge the SIGN ON and give the terminal instructions, such as:

*Standby for Assignment, Press ENTER to acknowledge
Nothing to do, Press ENTER and See Supervisor
Pick Item 1234*

If there is something for the Terminal to do, the host should send instruction to the terminal (as in "Pick Item 1234" above). If there is nothing to do at the time of SIGN ON, the host should acknowledge the SIGN ON and tell the terminal to *Stand By or See Supervisor* (see lines 1 and 2 above). You will notice that in lines 1 & 2 above, there is a request for the operator to press the ENTER key. This is required for the message to be a valid command - remember that all messages must end with a request for data input. The host should then expect a response from the terminal of **Terminal ID** + DATA (none if only pressing ENTER key) + **CR**.

SIGN ON is a good way for the terminal operator who has not received instruction from the host for several minutes to determine if he is still connected and if the host is still functioning. By SIGNing OUT and SIGNing back ON, the operator should receive a message that there is nothing to do. It is also a good idea for the host to keep track of elapsed time that a terminal has not had a message sent out to it. The host should then send a message periodically to re-assure the operator (remember to ask him to press ENTER) that instruction is coming or tell him to see his supervisor for re-assignment (or whatever makes sense for your application).

Ideally, if the operator is leaving the area (to go to lunch or move to another building) before he is out of range of the network, he should SIGN OUT, then SIGN ON upon his return.

A 6 line display terminal configured as a 6 line display (see Installation and Setup for LCD DISPLAY MODE) sends **ASCII 22** as its SIGN ON character. A 6 line display terminal configured as a 4 line display will transmit the ASCII 15 character for SIGN ON.

SIGN OUT

When a RF Terminal is powered down manually or the user presses the F1 key to exit data entry mode to go to one of the other modes (SETUP or ONE WAY), the host receives the following SIGN OUT message:

Byte position	Function	Possible values
1	RF Terminal ID	0-9, A-Z, a-z, - =
2+	SIGN OUT	SO (ASCII 14)
Last	Termination of message	CR (ASCII 13)

Base Station Error Feedback

The following are four different unexpected feedbacks that the Base Station can send back to your program: (Be sure to look for each of them to be sure your program doesn't blow up at an unexpected time.)

Addressing a Terminal not SIGNED ON

If the host attempts to send a message to a terminal that is not SIGNED ON, the Base Station sends back the following message to the host computer:

Byte position	Function	Possible values
1	RF Terminal ID	0-9, A-Z, a-z, - =
2+	Terminal NOT Signed In	DC1(ASCII 17)
Last	Termination of message	CR (ASCII 13)

The ASCII 17 character can be changed to ASCII 16 for XON/XOFF sensitive systems by changing the Base Station Setup. See [Chapter 3; Base Station Setup](#) for details.

If the Base Station receives five **Addressing a Terminal not SIGNED On** messages in a row, it transmits the following message to the Terminal and shuts down: (it will recognize a reinitialize command (*@EOT) from the host though)

**Base Shut Down
Due to Host Logic
Error**

Check your program for the sequence error before starting again. The host program will have to reinitialize the Base Station or you will have to cycle power on the Base Station and have the Terminal Sign On again in order to continue.

Sequence Error Message

The host program must observe the one-for-one "host prompt/terminal response" protocol at all times. The host cannot send a second data entry prompt until it has received a response to the first data entry prompt. If it does, this is considered a **Sequence Error**. If the Base Station receives a command that is out of sequence, it sends the following message back to the host:

Byte position	Function	Possible values
1	RF Terminal ID	0-9, A-Z, a-z, - =
2+	Sequence Error	DC2 (ASCII 18)
Last	Termination of message	CR (ASCII 13)

If the Base Station receives five **Sequence Error** messages in a row, it transmits the following message to the Terminal and shuts down: (the only host command that it will receive is *@EOT)

**Base Shut Down
Due to Host Logic
Error**

Check your program for the sequence error before starting again. You will have to reinitialize the Base Station by host program control (*@EOT) or manually cycle power on the Base Station and have the Terminal Sign On again in order to continue.

Invalid Command – Illegal Statement

When a terminal receives an illegal statement from the host, it will display a “?” and the RF Terminal sends back the ID # and ? to the Base Station, which then sends that to the host software.

Byte position	Function	Possible values
1	RF Terminal ID	0-9, A-Z, a-z, - =
2+	Illegal Command	?
Last	Termination of message	CR (ASCII 13)

For example, if Terminal ID #2 received an invalid command, the Base station would transmit to the host:

2?CR

If a command is sent from the host to the base station without a valid terminal ID character, such as:

@1,1,1,Scan Serial Number

since the command doesn't specify which terminal it is meant for, the base sends the following message back to the host:

***?CR**

If the Base Station receives more than 1000 characters, it treats that statement as an Invalid Command. If it sees more than 1000 characters five times in a row, it transmits the following message to the Terminal and shuts down:

**Base Shut Down
Due to Host Logic
Error**

You can re-initialize the terminal by sending *@EOT or by powering the base off and back on.

If you send the *@ will cause the Base to Restart – All Terminals will receive the message **“Base Reinitialized, Cycle Power & Sign-On Again”**

If you send the n@ (where n is the RF Terminal ID) this will reset the RF Terminal – The message on the RF Terminal will be **“Buffer Initialized, Cycle Power & Sign-On Again”**

To recover from an Invalid Command, resend the correctly formatted prompt to the RF Terminal that had the error and it should recover correctly. You should also clear the screen to make sure nothing is still on the screen.

Automatic Check Back

When a terminal checks back in to see if there is a change in instructions, the host can send back the same prompt or send back a new prompt. The check back occurs according to the time specified in the Terminal's setup, (specified in increments of 5 seconds). When a check back occurs, the Terminal clears the screen of the current prompt, and sends back the following message:

Byte position	Function	Possible values
1	RF Terminal ID	0-9,A-Z,a-z,-=
2+	Check Back	BEL (ASCII 07)
Last	Termination of message	CR (ASCII 13)

Base Station Initialized Message

Whenever the Base Station is powered up, it sends a message back to the host as follows:

Byte position	Function	Possible values
1	BASE ID	* (Base ID is fixed)
2+	Base Initialization	DC3 (ASCII 19)
Last	Termination of message	CR (ASCII 13)

Since ASCII 19 is XOFF, the ASCII 19 character can be changed to ASCII 20 for XON/XOFF sensitive systems by changing the Base Station Setup. See [Chapter 3; Base Station Setup for details.](#)

The **Base Station Initialized** message is provided so that the host will know that there has been a power interruption on the Base Station. When a serial device powers up, the first byte transmitted is often garbage. QBASIC handles the garbage character without incidence, but GWBASIC does not unless ON ERROR GOTO is used to trap the error. Be aware of this potential garbage-byte problem in your programming. To isolate and test for the problem, power up the Base *without* the serial cable connected. After you power the Base up, plug in the serial cable. You will *not* see the **“Base Initialized”** message but it should not matter when testing for the garbage data.

If a terminal is signed-on to the system, and the base station is re-initialized, the following message is sent to the terminal:

**Base Reinitialized X
Cycle Power on RF**

Terminal and Sign-on again to Restart_

where *X* is either a **P** (base initialization was power-related) or **H** (base initialization was host-related).

Control Keys for Possible Programming

There are some keys on the RF Terminal keypad that when pressed, can transmit special ASCII characters back to the host program. This feature might be used by a programmer to allow the operator to review transactions. **You can use these keys for special program functions, such as scrolling through data, backing up steps, jumping, finishing a process, etc.** The keys are as follows:

Key	Code transmitted to Host
UP ARROW key	FS (ASCII 28)
DOWN ARROW key	GS (ASCII 29)
LEFT ARROW key	RS (ASCII 30)
RIGHT ARROW key	US (ASCII 31)
BEGIN key	ETB (ASCII 23)
END key	CAN (ASCII 24)
SEARCH key	VT (ASCII 11)

The STATUS key is reserved to only display the Time and Date.

The Control keys can be used *without* pressing the ENTER key by using the **Control Keys Only** Terminal Setup parameter. See [Chapter 2; RF Configuration](#) for details.

ASCII Control Character and Extended ASCII Conversion (2D scanner only)

Since some ASCII characters are used to frame the RF packet all ASCII codes in the range 00h-1Fh and 80h-FFh are converted to %nn where the “nn” is the ASCII value. This only applies to 2D data packets.

Chapter 7: Programming Tools

Drop-in components are tools that are added to your programming environment "tool kit". There are a variety of different technologies around for implementing a drop-in component such as ActiveX and .NET assemblies.

PromptCOM/ActiveX is a drop in COM component that allows programmers to easily add the ability to send prompts to and receive data from their RF Terminal via an RF Base Station. It is compatible with Visual Basic, Visual C++, Delphi, and most other 32-bit development platforms. *See the help file for the tool you are using for detailed installation instructions.*

Programming Considerations for ActiveX

Before making any method calls, make sure you:

- Set the COM port properties (device name, baud, parity, bits,) as desired. Make sure the port is closed (call **CloseDevice**) before making changes to any of the port settings.
- Call the **OpenDevice** method. This activates the COM port used by this instance of the **WDterm** control.
- Set the **ActiveTerminal** property to identify the terminal on which you desire to operate. You can change the **ActiveTerminal** at any time in order to direct commands to appropriate terminals.

Test For Good Communication – ActiveX Object

Implement an event handler for **OnTermBaseRegister** that causes a beep or displays a message when called. If communication between the host PC and the base station is good, your event handler will fire when your program is running and you power up an attached base station.

Multiple Base Stations

For installations using multiple base stations attached to a single host PC (these were called "channels" in PromptCOM/DLL) simply add a **WDterm** control to your application for each base station.

Terminal Tracking

Since you get one set of event handlers for each base station, you will need some scheme for keeping track of where each terminal (up to 64 per base station) is in its transaction sequence. One possible solution is to use a "state" variable for each terminal (perhaps stored in an array). Test the state variable to determine the next prompt for any given terminal. See the samples for more ideas.

It is very important to keep track of "login status" for each terminal. Every **SignOut** event should have an associated **SignIn** event and a given terminal should not be allowed to **SignIn** twice without an intervening **SignOut**. Multiple **SignIns** from one terminal without appropriate **SignOuts** indicate either:

- A terminal going out of range and having its power cycled before returning within range OR
- Two (or more) terminals using the same ID (terminal ID conflict).

Concepts - ActiveX Object Programming

When you use drop-in components in your program you will follow the standard object-oriented programming paradigm that uses properties, methods, and events to implement the functionality of the drop-in component.

- **Properties** are the various configuration variables used by the drop-in component. An example of a property is the **ComDeviceName** setting.
- **Methods** are function calls used to issue commands and access features of the drop-in component. An example of a method is sending an **Input** command to the terminal.
- **Events** are function definitions placed in your application's source code. The function definitions in your source code are called Event Handlers. The skeleton structure of the event handler's source code is automatically generated. The code in the Event Handler is called ("fired") by the drop-in component when a specific event occurs. An example of an event is when a terminal returns data and the **OnTermData** event is fired.

The details of how to access Properties/Methods/Events varies between development platforms. Details of how it works in some of the most popular platforms is illustrated in the samples available for download from our website at:

<https://www.barcodehq.com/downloads.html>

Properties – ActiveX Object

Properties are the various configuration variables used by the **WDterm** control. They are directly assignable in your application (e.g. "**WDterm.ActiveTerminal = 5**") and can be set in your development environment's object browser.

Important: Except for **ActiveTerminal** and **Quiet**, all properties require the serial port to be "closed" before they can be changed. Use the **CloseDevice** method before setting properties and then call **OpenDevice** to re-open the serial port.

Note that your development environment may show more properties for the **WDterm** control than are listed here. This is normal. You may ignore properties you see that are not listed here.

Methods – ActiveX Object

Methods are commands that you issue to the **WDterm** control. All of the "**Inputxxx**" commands cause the terminal to wait for operator input.

*Note that your development environment may show more available methods for the **WDterm** control than are listed here. This is normal. You may ignore methods you see that are not listed here.*

Important: When your application starts up, the serial port is "closed". You must call **OpenDevice** before other method calls will work.

Except for the **RelnitAll** method, all methods use the **ActiveTerminal** property to identify the terminal to use.

Events – ActiveX Object

WDterm events occur when a specific condition is met. When an event is "fired", an event handler function in your application is called.

Though the details of exactly how it is done varies from one programming environment to the next, the source code skeletons for the various event handlers are automatically generated and inserted into your source code for you. See the samples for more specific information.

Each event passes relevant information to your event handler function. The only event that does not pass any data is **OnTermBaseRegister**. All others pass at least the Terminal ID on which the event occurred. **OnTermData** also passes the data that was keyed or scanned into the terminal.

Terminal ID is always passed as 0-63. A Terminal ID value of 99 indicates an error.

Once you have the event handler skeletons, you can proceed to add whatever functionality you desire to each event.

You must call the **OpenDevice** method before any events can be fired.

.Net programming component

The **WDTerminal.dll** .Net assembly is a drop-in component compatible with all .Net IDEs and all supported .Net programming languages. Please note that the required SDK level for your programming project is .Net Standard 2.1. You cannot use the assembly with projects that target the .Net Framework versions 4.8 and below. This component provides support for the 7000 series RF Terminals as well as the 7800 series WiFi terminals.

The API for the .Net component has been largely kept backward compatible with the prior ActiveX component. Additional functionality is provided but programmers wishing to add the .Net component to pre-existing ActiveX projects will find that minimal code changes will be necessary, other than modifying certain method and event signatures.

Programming Considerations for .Net Assembly

Unlike the ActiveX component which acts as the main component for all communication, the .Net assembly provides a class, **RFBBase** which can be dropped onto a form or instantiated separately as a class member in your forms. The **RFBBase** class is the main conduit for communicating with your RF terminals.

Before beginning communication, you must ensure the following:

- For the 7000-series terminals, make sure that you set the COM port properties (Com port number, baud rate, etc). If you are communicating with the WiFi terminals, make sure that you set the port number for the TCP/IP communication (e.g., “8080”). The IP Address is automatically set to the address of the machine on which your application is running.
- Call the OpenDevice method. This starts the listening process for the RFBBase object.
- When receiving data from a terminal, it will be provided in the form of an event. In your event handlers, you can continue to set the ActiveTerminal property before communicating with the terminal that sent data, however, the RFBBase also provides an alternate method, GetCommandBuilderForTerminal which is thread-safe and the recommended way to respond.

Test for good communication

The RFBBase class requires that all event handlers are implemented before you can call the OpenDevice method. If an event handler is not implemented, the RFBBase object will throw an exception. The event handlers can be empty, but it is strongly recommended that you provide some code handling for each one. The error event handlers are there to protect your application from unexpected behavior!

When testing for communication, you can use the OnTermBaseRegister event to detect a base station power up when your application is running. The RFBBase class also provides methods to detect which serial port the base station is attached to, and you can call this method to set the com port parameters prior to calling OpenDevice.

Multiple Base Stations

For installations using multiple base stations attached to a single host PC simply instantiate an additional RFBBase object for each COM port that has an attached base station. WiFi terminals do not communicate through a base station, so there is no need instantiate additional RFBBase objects unless you want to partition the WiFi terminals among separate TCP/IP ports. The same principle applies: create additional RFBBase objects that specify different port addresses.

Terminal Tracking

It is very important to keep track of "login status" for each terminal. Every SignOut event should have an associated SignIn event and a given terminal should not be allowed to SignIn twice without an intervening SignOut. Multiple SignIns from one terminal without appropriate SignOuts indicate either: A terminal going out of range and having its power cycled before returning within range OR Two (or more) terminals using the same ID (terminal ID conflict). NOTE: WiFi terminals do not send a SignOut event. You will need to implement a different kind of tracking for this type of terminal.

Concepts - .Net Object Programming

- The RFBBase class follows the standard object-oriented programming paradigm that uses properties, methods, and events to implement the functionality of the component.
- Properties are the various configuration variables used by the component. An example of a property is the ComDeviceName setting.
- Methods are function calls used to issue commands and access features of the component. An example of a method is sending an Input command to the terminal.
- Events are function definitions placed in your application’s source code. The function definitions in your source code are called Event Handlers. The skeleton structure of the event handler’s source code is automatically generated. The code in the Event Handler is called ("fired") by the component when a specific event occurs. An example of an event is when a terminal returns data and the OnTermData event is fired.

For a complete listing of the properties, methods and events for the RFBBase class, please see the help file that is distributed with the WDTerminalLib.dll.

Chapter 8: *Portable Printers – BT Settings*

Portable Printing - Common Information

The LT7150H & LT7250H Models come equipped with an additional radio module allowing you to wirelessly connect to a portable printer to print labels, receipts, or price tags.

There are many types of portable label printers - Like Zebra QLx & ZQx line of printers as well as the TSC Alpha Series printers. These types of portable printers can print simple receipts or labels – you can even include bar codes on the receipts or printed labels.

Keep in mind the following information when using these versatile printers:

- The @S command is used to send data to the printer. Any turn on, or "Wake-up", is accomplished by the radio module in the RF Terminal and the Printer – it will check to see if the printer is ready, so only the @S command and the data you are sending to the printer is needed.
- The 231 character limit applies to your command string. See your **Portable Printing Systems Programming Manual** for details on programming your specific printer.

Chapter 9: Voice Message Operations

The RF Terminal's exclusive use of voice prompts allows you to overcome problems such as literacy, language and lighting. With proper planning, voice prompting can enhance your RF Terminal application, making it faster and simpler. Voice messages are recorded (or imported from existing sound files) and uploaded to the RF Terminal using the **Integrated Hardware Utilities** program. Playback of a voice prompt is triggered by a prompt from the host computer.

Why Use Voice Messages and Prompts?

- Voice messages can be in *any* language.
- The operator does not have to be able to read to perform some jobs.
- Voice Prompts can be very helpful in dimly-lit or extremely-cold environments.
- The data collection process is faster because the operator does not have to continually look at the screen for instructions. This is especially useful when you do not want or need to enter data from the keypad. Scanning bar coded numbers from a Quantity BARPAD can make keying unnecessary.
- Voice messages and prompts are a good way to keep the operator's attention focused on the job at hand. Audible error messages and warnings also help to limit mistakes and downtime.

Voice Prompts and the Hardware Utilities 3.0 program

The Hardware Utilities 3.0 program makes it easy to manage your RF Terminal system's Voice Prompts:

Download if from our website at:

<https://www.barcodehq.com/downloads.html>

- Record custom RF Terminal voice prompts using your computer's built-in or external microphone.
- Import custom RF Terminal voice prompts from existing sound files.
- Edit RF Terminal Voice Prompts to trim off any extra seconds of silence or noise before or after the actual words of the Voice Prompts.
- Increase the volume of RF Terminal Voice Prompts that aren't loud enough.
- Delete unwanted RF Terminal Voice Prompts.
- Rename RF Terminal Voice Prompts to correct or update the descriptions you had entered for them.
- Renumber RF Terminal Voice Prompts to change the Voice Prompt numbers assigned to them.
- Restore Default RF Terminal Voice Prompts you had replaced or edited.
- Send Voice Prompts to one or more RF Terminals.

See the Hardware Utilities 3.0 program help file for complete instructions on using the Hardware Utilities 3.0 program.

Tips for Using Voice Prompts

Up to 99 voice messages can be recorded and stored in the RF Terminal. Here are some tips on making your voice prompts user-friendly:

1. **Short messages** are preferable for prompts; most English prompts can be stated in ½ second. Instead of saying, "Enter the Item Number," say "Item". The typical RF Terminal operator does not want to hear long messages thousands of times. Error messages are typically longer because they are the exception and need to provide more precise instruction to the user.
2. **Record your voice prompts calmly.** A frantic sounding voice can become irritating, especially when heard repeatedly.
3. **Speak clearly.** Correct pronunciation will make the voice prompts easier to follow for all users. Use common words that all users will understand.
4. **Vary the tone of your voice for different prompts.** Using a different tone of voice or even a different voice for consecutive prompts or error messages will make it easier for the user to distinguish between them.
5. **Don't be discouraged** if your first attempts at recording Voice Prompts don't sound very good. Again, practice speaking clearly and calmly, and you'll soon get the hang of it.

6. **Be sure to record error messages for *all* possible problems** that the user may encounter during a session. Once the operator becomes accustomed to listening to the voice prompts, it may become easy to overlook a “display only” error message.

Assigning Error Messages

The RF Terminal comes from the factory with some voice prompts and error messages pre-recorded. You can change any of these messages but keep in mind that the error conditions are hardware-related and that the voice error messages they are linked to are fixed. For example, the “**Low Batteries**” message is located at message #98. Whenever the RF Terminal detects very low batteries, it will play message #98, regardless of what is recorded there. You could record “Happy Birthday” and the RF Terminal would broadcast it any time it detected the low battery condition. To avoid confusion, try to keep the error messages somewhat related to the error condition they represent.

Default Voice Messages

Here are the default messages and the numbers they are recorded under:

Message Recorded	Message #
Prompt	
ITEM	#01
QUANTITY	#02
Error messages	
LOW BATTERIES	#98
TRANSMISSION FAILED	#99

Chapter 10: Troubleshooting

General Considerations

RF Site Survey Test

The most basic tool for troubleshooting is the RF Site Tests starting at around 50 feet of range. (See [Chapter 5: Site Test](#) for the details on how to do a Site Survey). If the Site Survey numbers are low at close range (50 feet), you have an RF problem.

The first thing to check is that the antenna is screwed all the way down, and tight – check both the Base Station and the RF Terminal(s) antenna.

The Base Station antenna takes around 4 complete turns to seat correctly. In addition, the Base Station antenna can be damaged if it is bent – which will break the internal wire and give very poor range.

You can verify the Base antenna is good by removing the antenna completely – and then doing a RF Site Survey with a known good RF Terminal. If your Site Survey results are *the same with the antenna removed* from the Base Station only, then the Base Antenna is most likely damaged. If your results are even **worse** with the antenna removed from the Base Station, then the antenna is probably not the problem. That would then point to the radio on either the Base Station or the RF Terminal as defective.

If you have multiple RF Terminals and/or multiple Base, or Relay, Stations, after a Site Survey failure, you can determine if the failure is with an individual Terminal or the Base by substitution. If you have only one Terminal and Base, you have no way of knowing which has failed; you must call us and get an RMA for both units to be checked out at the factory in Santa Cruz, California.

If the RF Site Survey test gives 90%+ numbers, there is nothing wrong with the radios.

Changing the Battery HXX50 Handle Assembly

For RF Terminals, the most frequent cause of problems is a low battery that has either been ignored or undetected. The real test for the battery is to remove HXX50 Handle Assembly from a working unit and place it into a suspect unit. When charging the battery use the Worth Data F17 power supply and the C26 USB Cable. Do not attempt to charge by plugging the unit into a computer – there will not be enough current to charge the battery. The units need at least 10w of power to charge via the type C USB ports.

Most of the time the battery becomes the problem as a result of:

The operator ignores the **Low Batteries** message and doesn't finish up the transaction and immediately charge the battery. If you turn the unit off and turn it on again, the battery may have had time to “almost” recover. Unfortunately, they will have so little reserve power that they will likely operate just long enough to produce some very screwy behavior on the RF Terminal. Intermittent laser beams, continuous beeping, a blank screen, are just a few of the symptoms that can be exhibited.



⚠ WARNING: LI-ION BATTERY CHARGING

1) Be sure to follow the rules listed below while charging the battery. Failure to do so may cause the battery to become hot, rupture, or ignite and cause serious injury.

- When charging the battery use the Worth Data F17 power supply and the C26 USB Cable.
- Use only one of the USB C ports on the unit for charging – it will not work properly if 2 USB cables are connected.
- Do not use or attempt to charge a battery that has been damaged from drops, has had contact with water or other liquids, or may have any other damage.
- Do not place the batteries in or near fire, or into direct sunlight. When the battery becomes hot, the built-in safety equipment is activated, preventing the battery from charging further, and heating the battery can destroy the safety equipment and can cause additional heating, breaking, or ignition of the battery.

(2) Do not continue charging the battery if it does not recharge within the specified charging time. Doing so may cause the battery to become hot, rupture, or ignite.

Problems with a new installation:

If your RF Terminal continues to generate a "**Transmission Failed**" message, your radios are not communicating. Be sure they're on the same channel and try again. If you have multiple terminals, try another terminal. If the 2nd terminal also fails on the same channel, the base station is bad. If the 2nd terminal passes the Site Survey Test, the first terminal is bad.

If the Terminal displays the "**Waiting Host Prompt**" message, the host program is not communicating with the Base Station. There is no radio problem, because the Base Station has already acknowledged the Terminal's Sign In. The Terminal is waiting on the Host to tell it to do something. Try the demo program; if it works then the problem is your software program.

Your software might not support the 15 Line LCD of the 7x50 RF Terminals – in that case try one of the [LCD Legacy settings](#) (4 Line or 6 Line) to see if one of those settings works with your software.

If the demo program fails, the problem is one of the following:

For Serial Connections:

- The cable between the Base Station and host computer is bad. Try the test with any extension cables removed.
- The host COM port is bad or assigned to another device driver on the system. Try another COM port or try another computer.
- RARELY!!! The RS232 chip on the Base Station is bad.

For USB Connections:

- The USB Device Driver is not installed, or registered, on the system properly
- The USB Device COM port assignment is not configured in your software correctly. This can be changed in the USB Driver Properties in **Device Manager** on a Windows system.

Look for a **!** next to one of the devices in Device Manager.

With the USB Driver properly installed you should see the port as shown on the right under "Ports (COM & LPT)". Windows will automatically assign a COM Port number – in this example it is set to COM6

Make sure the COM Port number that is shown in Device Manager is the same as is set in the Host Software.

You can change this in the Properties of the USB Serial Port is needed.

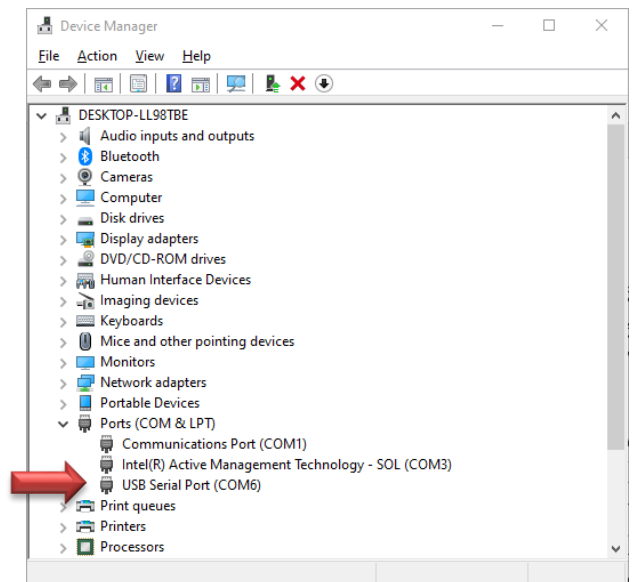

RF Terminal Error Messages

RF Terminal Message	Meaning – Action Required
<p>Transmission Failed. ENTER to Retry; F1: Exit, F2: Help</p>	<p>The RF Terminal has tried 10 times to get its message through to the Base Station with no success. Make sure the Base Station and RF Terminal are set to the same RF Channel. Could be result of bad radio in base or terminal. Could be the operator has gone out of range of the base - if so, move closer and press any key. Could also be that there are too many terminals competing for radio time on one base station.</p> <p>Another option is to do a RESET TO FACTORY DEFAULT in the SYSTEM TOOLS section – This will RESET and problem settings that may be incorrect.</p> <p>Pressing F2 Gives the following Help:</p> <p>Please Verify:</p> <ol style="list-style-type: none"> 1. Base Station Power ON 2. Base and Terminal are set to the Same Channel 3. Antennas are installed properly on Base and Terminal 4. Refer to the User’s Manual for more info. <p>Press Any Key to Re-Start</p>
<p>Waiting Prompt from Host Computer: F1: Exit; F2:Help</p>	<ul style="list-style-type: none"> • Problem is between Host computer and Base station. Check to see if host software application is running. • Check the USB Serial ports settings – make sure your USB driver is properly installed and the COM Port value in the driver matches up in your software. • Check serial parameters and eliminate any extension cables. Run the Demo program. Try another COM port or another computer. • Check that your application software supports a 15 Line LCD – if your software does not support a 15 Line LCD you will need to set the LCD Legacy Mode to 4 or 6 line. <p>Pressing F2 Gives the following Help:</p> <p>Please Check:</p> <ol style="list-style-type: none"> 1. Host Software is running 2. Base Cable Connection to the Host Computer 3. COM Port Settings for USB or Serial Connection 4. LCD Legacy Settings on RF Terminal. 6 Line or 4 Line Mode may be needed 5. Check for Duplicate ID’s 6. Refer to the User’s Manual for more info. <p>Press Any Key to Re-Start</p>
<p>?</p>	<p>See the Invalid Command – Illegal Statement section in Chapter 6: Programming</p>
<p>Base Station Shut Down Due to Host Logic Error, Cycle Terminal Power</p>	<p>Problem is in host program. Notify programmer!</p> <p>If the Base Station receives 5 Sequence Errors in a row, it transmits the message to all terminals signed in and shuts down. Check your host program for the sequence error before starting up again. OR</p> <p>If the Base Station receives 5 messages addressed to a Terminal not Signed ON, it transmits this message to the all terminals signed in and shuts down. You will have to cycle power on the Base Station or you can send a command (*@EOT) form the host and have the Terminal Sign On again to continue.</p> <p>Make sure only one Base Station is in the vicinity on a given RF Channel – another base on the same RF Channel can cause this error.</p>
<p>Base Reinitialized X Cycle Power on RF Terminal and Sign-on again to Restart_</p>	<p>Base Station has been reinitialized. If message reads “Base Reinitialized P”, then reinitialization is due to a power problem. If “Base Reinitialized H” then the reinitialization was initiated by the host program. Fix problem (cycle power on Base or re-initialize from host program).</p>

Buffer Initialized Cycle Power and Sign-on Again_	The host program has reinitialized the buffer in the Base Station for this terminal only. The Base is still operational and ready for you to power off your terminal, power on, and SIGN ON again. Other terminals are not affected.
Relay X Cannot be Heard by the Base Notify Supervisor	The terminal has established contact with Relay Station x. Relay Station x has attempted to communicate with the Base Station through the 422 cabling with no success. Cable is bad. Maximum length of the data packet sent is 500 characters – if your command is over this amount it can cause this error as the relay has extra bytes it sends that may exceed the radio packet limit and give this error.
One Way Not Allowed Base in Other Mode Press <Enter> Key	One-Way is not allowed if the Base is already in some other mode such as Two-Way or Site Testing which was not properly concluded. Also, if you are SIGNED IN in One-Way mode and someone else SIGNS IN in Two-Way mode, the person in One-Way mode will be kicked out of the system with this message. Two-Way mode ALWAYS supersedes all other modes.
Site Testing Not Allowed, Base in Other Mode Press <Enter> Key	Site Testing is not allowed if the Base is already in some other mode such as Two-Way or One-Way which was not properly concluded. Also, Two-Way mode ALWAYS supersedes other modes. If you are Site Testing and someone SIGNS IN in Two-Way mode, you will be kicked out of the system with this error message.
Duplicate Terminal ID, Notify Supervisor Press Any Key to Turn off Terminal	With one ID already SIGNED IN to the host, a second terminal with the same ID tried to SIGN IN. Every terminal requires a unique ID for proper system operation.
No Firmware Detected 1 – Download Firmware 0 – Power off Terminal Press 0 or 1 now	The firmware has somehow been wiped out – probably from an interrupted firmware download. Press 1 to Download Firmware or press 0 to power off the terminal.
LOW BATTERY Finish, Sign Off Charge Battery	Finish the transaction you have started. The Press F1 to Sign Out. Then turn off the Terminal and charge the battery. This is an early warning that the battery is getting low and should be charged soon.
CHARGE BATTERY UNIT SHUT DOWN	The terminal will display this message for 20 seconds, sign out, and turn off. The unit will not operate until the battery is charged.
Radio Module Bad – Press <F1> to Exit	The Radio on the last power up failed – this will happen if the Radio Module has failed or is damaged. The Radio Module will need to be replaced. Call Worth Data for an RMA
CHARGE FAULT !!!	The HX150 Li-ion Battery may be bad . One of the USB Ports may be bad – <i>try the other port or a new cable</i> This error can also occur if you are using a USB charging adapter, and/or a USB cable, that doesn't provide enough current. The RF Terminal needs a higher power USB Charger – at least 10w (2.0A). The F17 Power Supply and C26 USB cable that came with the unit are the recommended parts for proper charging of the unit.

Reminder: Two or more terminals with the same **Terminal ID** can generate all kinds of strange messages.

Two bases on the same RF Channel, within range of each other, will also cause big trouble.

Base LED Color Meaning

Base LED	Meaning – Action Required
RED LED	Solid Red LED means a Host Logic Error was detected – See the Trouble Shooting section above. Red Flashing LED means the Radio Module is bad or cannot communicate. Call us for an RMA.
GREEN LED	Base operating as a Base (default configuration)
ORANGE LED	Base operating as a Relay

Sometimes you get an error message and after checking, everything on the Base seems to be set OK. Drop power on the suspect Base and try signing in again. If you get the same message, there is another Base answering which should not be on the same channel.

Troubleshooting specific problems

I can't communicate at all...

- Use the *Hardware Utilities* Test Program to verify if you can communicate.
- If the Test Program works then you need to check your communication link from the Base Station to the host. Use the following command to test the transmission of data from host to Base and back again to the host:
- @@*Edataaaaaaa<EOT>
- where *dataaaaaaa* is any string of data, terminated by EOT. This string should be sent from the host to the Base Station. If the data is received by the Base, it echoes it back to the host in the format:
- dataaaaaaa<CR>
- where *dataaaaaaa* is the data string from the original transmission, terminated by a CR (ASCII 13). This test verifies communication in both directions (host to Base, Base to host).
- If the data isn't echoed back, either your host COM port, USB connection, or the Base Station has a problem.
- Once you know the Base Station is communicating with the host correctly, compare the channel of the Base Station with the channel of the Terminal. Use Site Survey to check the communication of the Terminal to the Base and back. Make sure no other Terminals are in use, and go to Site Survey on the Terminal. You should get 80-100% at greater than 10 feet. If you don't, it's a good chance your radios need repair. Call Worth Data for an RMA.
- If you are using PICK or UNIX as your operating system, make sure the Base Station is set to "XON/XOFF Sensitive".

My response time is poor...

- First, do Site Survey 50 feet from the Station. If it's not 90+%, the Radio in the Terminal or the Base Station is the problem.
- Second, run one of the demo programs. If the demo runs fast, it is your program that is slow.
- If you have good response time everywhere but on the outer fringe area you may need to relocate your Base Station.

I'm not getting the distance I need...

To maximize range, the Base Station and Relay(s) should be located:

- At the center of the area of intended coverage, and
- As high as possible - mounted on the ceiling of a room with the antenna pointing downward works the best. Sometimes just raising the Base Station to 12 feet will dramatically increase the distance, especially in warehouses or grocery stores with tall shelving. A Base Station mounted on the wall with the antenna parallel to the floor is the worst position.
- In an unobstructed outdoor area, a range of 3 miles or greater "line-of-sight" is possible but indoor "obstructed" range will be much less. Reflections and obstructions, depending on the density and material, can reduce the range to a few hundred feet indoors, which is still far better than typical Wi-Fi systems.
- To accurately determine the hardware required to cover a particular area, you should use the Site Survey mode built into the RF Terminal. You can also try the newest Alternate RF Channels A-F – which may improve range in certain situations.

I can't communicate with the RS-232 port host CPU...

- For Serial COM port connections, if you are not using our F36 or F34 Serial cables, check your cables first. If you have an extension cable, remove it for testing. If you have a serial extension cable of 80 feet or more attached to a Windows host, you need to be sure certain pins are not attached in the DB9 or DB25. See [Chapter 3: Base Station Cable Options](#).
- If you are using the PICK or UNIX operating systems, be sure you have set the Base Station to be "XON/XOFF Sensitive". You need to do this to prevent the XOFF code being sent as a "Base Initialization" message.
- Windows COM port setup should also be changed to turn off XON/XOFF. XON/XOFF is the default for Windows. You set these through the control panel, *System, Device Manager, Ports (COM & LPT), COM Port, Port Settings, Flow Control*. Set *Flow Control* to None.

I can't communicate with USB Port on my host CPU...

- For USB Connections, make sure the USB device driver is installed and running correctly - you will also need to know the COM port assigned by the system – this can be checked in *System, Device Manager, Ports (COM & LPT), USB COM Port, properties*.
- USB extension cables can cause power and connection problems. USB 2.0 is limited to having a maximum total length of 5 meters, around 15 feet – our C21-2 USB Cable is 2 meters (6ft) long, so if you need to use a longer cable make sure you get one that is no longer than 5 meters total, including our C21-2 cable. The USB cable should have 20AWG wires for power to use with our Base Stations.
- You can also use a **powered USB Hub**, or an **active powered USB extension cable**, for longer connections. We have tested 20 meter active powered USB cables with good results.

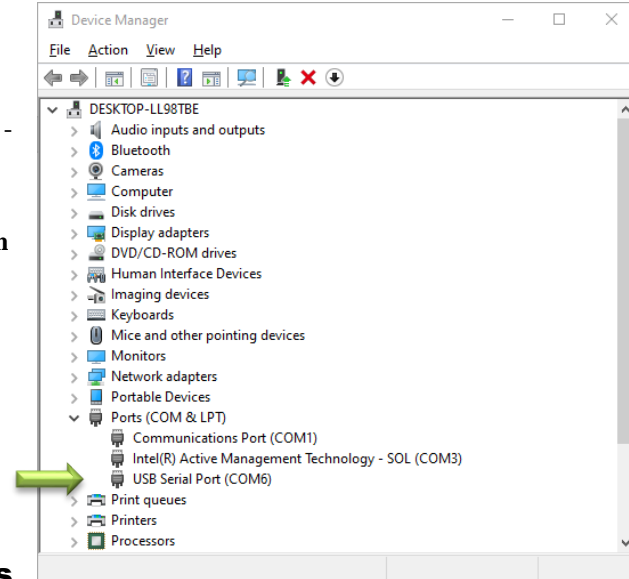

Poor coverage into, or out of, metal enclosed spaces or buildings

- An enclosed metal building, metal office, metal shipping container, including walk-in freezers or cold storage units can reduce range substantially. If it is not possible to place a Relay or Base Station in a place that provides good coverage into, or outside, of the metal enclosure – an option is to mount just the threaded antenna inside or outside the metal enclosure as needed. This can be done with a special low loss **RP-SMA Male to RP-SMA Female antenna cable** – we have tested cables up to 2 meters in length. Use as short a cable as possible. These cables will reduce range overall, but are helpful in metal shielded situations to get RF in or out.

RF Terminal Problems

RF Terminal fails to power up...

- The unit needs to have a battery with enough voltage to run – if the unit has been left unused for a long period of time, or put away when in a low state of battery charge, the unit may not power up. Attach your Worth Data F17 USB charger and C26 USB cable for several hours to get the battery to charge. Your battery can be damaged by sitting at a very low battery charge for long periods of time. Replacement HXX50 Handles battery assemblies are available from Worth Data.
- Make sure you are not trying to charge by plugging into a USB port on a computer – there is not enough power to re-charge the Li-Ion battery in the unit – Connect to the F17 USB Power Supply and the C26 USB cable provided with the unit.

When laser is triggered, it cycles power – Returns to Opening screen

When a voice message plays, it cycles power – Returns to Opening screen

When I turn it on, it just beeps continually, or the screen flashes continually.

- If the battery is very low, when turned on, the Terminal will just keep beeping; it is cycling power, over and over because the batteries are too low.
- If the batteries are at a specific low point, the laser triggering or playing a voice message will be just enough extra power draw to force the terminal to cycle power.
- Charge your Terminal for at least an hour, or even overnight, and try again.

I get 6 beeps when the RF Terminal powers up...or 3 beeps, 3 beeps, 3 beeps continuously over and over

- The unit needs repair. Call Worth Data for an RMA.

When Power is pressed it quickly powers up...and immediately powers off

- The units real time clock is off and the unit needs to be hard reset by removing the battery for 30 seconds. Remove the 2 screws holding the handle and remove the handle connector cable. Once the handle connector has been removed for 30 seconds, re-assemble the unit and it should power up correctly.

Problems reading Bar Codes

The reader won't beep when I try to read bar codes...

- Try reading a known good bar code - try the 1 on the Setup Menu bar pad table. Follow the steps for proper scanning technique discussed in [Appendix A; How to scan a bar code](#).
- Make sure the reader is configured to read the type of bar code you are trying to scan. Most bar code types are *disabled* by default and need to be enabled using the Setup Menu or keypad while in Setup Mode.

I get extra characters at the beginning or end of my bar code data...

- Clear the Preamble and Postamble settings.

I have very poor read rates when scanning bar codes...

- Carefully follow the scanning instructions in [Appendix A; How to scan a bar code](#) when reading any and all bar codes. As straightforward as scanning may seem, many people who call with a complaint about poor read rates simply aren't doing it right.
- Try reading the following bar code below as an example of a known “good” bar code. This bar code is a Code 39 bar code and is readable by the RF Terminal set to its default settings.

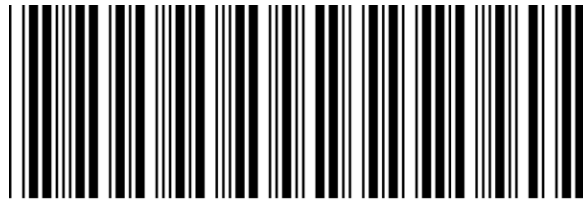

TEST LABEL

- Make sure *your* bar codes have clearly defined dark bars and clean white spaces. If the bars are so light that they are gray instead of black or are so dark that they “bleed” into the white spaces, the printing of the bar codes is the problem. Whoever is printing the bar codes needs to make the necessary corrections.
- The bar code should also have a “quiet zone” of at least $\frac{1}{4}$ ” to the left of the first bar and to the right of the last bar. Make sure the beam covers the bar code completely and “overscans” a bit on each end.
- Check the laser beam window at the top of the unit and make sure it's not dirty or scratched.

No Scan Beam

- On the opening screen the scan beam is disabled to prevent accidental scanning.
- You must Sign In, or use One Way mode, to test the scan beam.
- There are two ways to turn on the laser scan beam, or 2D imager. One is to use the scan button on the keypad, the second is the Trigger on a handle. If you are not getting a scan beam from either the scan button or trigger you will most likely need to send your unit back for repair.
- If you are getting a beam with the scan key press, but not when the handle trigger is pressed – it is possible that the handle is not connected properly to the RF Terminal, or it is damaged. Remove the 2 screws holding the handle on, and disconnect the cable and re-attach it firmly to seat it properly. Re-assemble and test the handle trigger – if it still fails you will most likely need to get a new HXX50 Handle.
- If you can't get a beam at all the unit may need to be sent in for repair.

Problems with Voice Prompts

- If you have any problems with RF Terminal Voice Prompts, read the “If you have problems” topic of the 7000 RF Terminal Voice Prompts program help file.

If you still have a problem...

- If you have a problem with your RF System, **consult the troubleshooting section of this manual FIRST**. As a last resort before calling for an RMA, you can follow the steps below to perform a diagnostic reset on your terminal. This resets everything back to the factory defaults, so be prepared to remake any setup changes (i.e. Terminal ID) you had made prior to the reset.
- Turn your terminal on, press the terminal's **2** key to select **Settings**.
- With the terminal displaying the RF Terminal Setup menu, press the terminal's **7** key to select **System Tools**. You may be asked for a password – the default password is **WDTRI**
- With the terminal displaying the System Tools menu, press the terminal's **2** key to reset all terminal settings to the factory defaults. Again, if you made any setup changes (such as changing the Terminal ID, or enabling a bar code type) you will need to make those changes again following the reset.
- If you cannot find the answer here, or if doing a system reset does not help, call your Dealer or Worth Data for help.
- Before you call your dealer, or Worth Data for technical support, have your RF Terminal and related equipment in front of you and **be prepared to explain your problem in detail to the Technical Support Engineer**.
- The Engineer may ask you to go through some troubleshooting procedures while on the telephone. This will help them determine what is wrong and what the course of action should be. **Many problems can be resolved over the telephone and will not require that you return the equipment to us**. If you *do* need to return any of the RF equipment to Worth Data, the Engineer will issue an RMA number.
- If you do need to return the RF Terminal for ANY reason, **you MUST have an RMA number** first. Write the RMA number on the outside of the original shipping box and make sure to insure the shipment. All RMAs should be shipped back to the following address unless directed otherwise:

*RMA #XXXXX
Worth Data Inc.
623 Swift St., Suite B
Santa Cruz, CA 95060
831-458-9938*

Chapter 11: Firmware Upgrades

Updates are occasionally available for the *RF Terminal System* when new features or improvements are added.

RF Terminal Firmware Upgrades

The RF Terminal firmware can be upgraded by downloading new firmware into the RF Terminal from your computer.

Normal Firmware Download for a Terminal

The RF Terminal firmware can also be upgraded by downloading a file with the current firmware into the RF Terminal's flash EPROM using the **Hardware Utilities 3.0** program found on our website at <https://www.barcodehq.com/downloads.html>.

If you have downloaded the firmware from our website at <https://www.barcodehq.com/downloads.html>, load the firmware into the RF Terminal by following the instructions on the screens of the program for a normal Terminal firmware update.

Failsafe Firmware Download for a Terminal

If a terminal's firmware gets completely wiped out (the terminal's battery or power adapter are tested to be good, but the screen stays blank screen or only displays a cursor when you press the power button) you will need to do a "Failsafe firmware upgrade" to restore the firmware.

To do a Failsafe firmware upgrade on a terminal that has had its firmware completely wiped out, run the Hardware Utilities program, select the "Failsafe" option, and follow the program's instructions as it walks you through the steps to perform a Failsafe firmware upgrade.

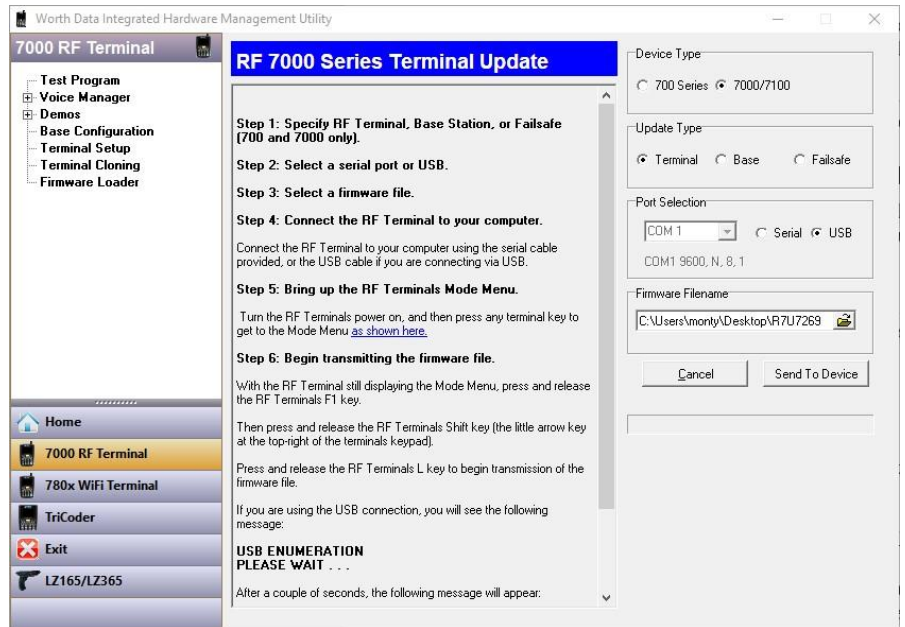

Base Station Firmware upgrades

You can download the latest firmware for the B5011 Base Station by going to our web page: <https://www.barcodehq.com/downloads.html> and clicking the "B5011 Base Station Firmware" Download button.

You can download the latest firmware for the B5021 Ethernet Base Station by going to our web page: <https://www.barcodehq.com/downloads.html> and clicking the "B5021 Base Station Firmware" Download button.

To do a Base Station firmware upgrade, run the **Hardware Utilities 3.0** program, select the "Base Station" option, and follow the program's instructions as it walks you through the steps to perform a Base Station firmware upgrade.

Appendix A: How to scan a bar code

This section will include information on different scanners as well as how to use each one.

1D Laser Scanners

Bar codes with mainly vertical elements – like the UPC code below are considered 1D bar codes. The **LT7150H** has a 1D Laser Scan engine built into the unit.

If you are using a laser scanner, technique is not critical. The scanners are “point-and-shoot”; you can’t miss. Upon triggering the beam, the laser scans the bar code multiple times (100 scans per second) until it has a good read, at which point it automatically shuts off. They read from a distance, so they are much more convenient for distance shelf scanning or scanning in tight spots. Different bar code sizes will determine the scanning distance capabilities. The only thing you need to do is line the laser beam up across the bar code to get it to read. Our laser scanners will read most 1D bar codes.



To scan a bar code using your laser scanner:

- Put your RF Terminal in One-Way mode with the host computer program not running.
- Point the laser scanner at the bar code at about 6” away.
- Pull the trigger (or push the Scan Button on the Keypad) and line up the beam on the bar code. If you don’t get a read, vary the distance of the scanner from the bar code by pulling up or moving down. The idea is to scan through the center of the bar code.

Laser Options

Several options are applicable to all laser scanners that are used with the RF Terminal. These options are: 1) Longer timeout on the laser reading, and 2) Double decode required.

Longer Laser Reading:

A temporary solution to problem bar codes is sometimes to increase the length of the time the scanner attempts to read, from the default 2-second beam to a 4.5 second beam.

Double Decode:

The default setting for the RF Terminal is one successful decode results in a “good read”. If you are getting incorrect reads, (due to defective bar codes), a temporary solution is to make the RF Terminal perform two straight identical decodes before beeping, outputting data, and completing a “good read” read.

Difficult Code 39 Reading:

This setting facilitates reading of difficult Code 39 bar codes such as the Vehicle Identification Number (VIN number) on automobiles, especially reading through a windshield. VIN numbers are long, often weathered, often dirty, and challenging to read.

To enable the more aggressive Code 39 algorithms necessary to read windshield VINs change the **Decode Option** to 1 or 2 in the **Code 39 Options** menu. A clean windshield also makes reading bar codes easier.

Filter Mode

If you are trying to read poorly printed bar codes, this setting may improve the performance of the decoder.

- Mode 0 is the default setting and works best with good quality bar codes.
- Mode 1 might help when reading codes printed with uneven levels of dark and light areas.
- Mode 2 might help when reading codes with poor print contrast (like a dark or colored background).
- Mode 3 might help when reading codes with holes or voids such as damaged or dot-matrix printed codes.
- When selecting mode 1 or 3 it would be a good idea to set double decode to ON to avoid errors.

Accumulate Mode

Accumulate Mode is an option allowing the RF Terminal to accumulate multiple bar codes in its buffer, then transmit them to the computer as if they had been a single bar code. This is useful for entering quantities and other variable data.

Accumulate Mode works with Code 39, Code 93 and Code 128 only and can't be used with a check digit. When the RF Terminal reads a bar code with a **space as the first character**, it beeps and buffers the data without transmission. It continues to read and buffer bar codes (up to 40 characters) until it reads a bar code **without a leading space**. Once it reads this last bar code, the entire buffer (including that last code) is transmitted as one long bar code. A “double-minus” sign (--) bar code clears the buffer. The **ENTER** code on this Barpad is a Code 39 *Start/Stop Character* only.

Accumulate Mode must be turned on using the bar coded Setup Menu or by using the keypad. *Accumulate Mode* is located in the Code 39 parameters. Choose **4** to *Enable* or **5** to *Disable* this feature.

This numeric Code 39 "Barpad" illustrates ACCUMULATE Mode. Scan **5, 3, 8**, and **Enter**. The RF Terminal transmits a single message of “**538**”.

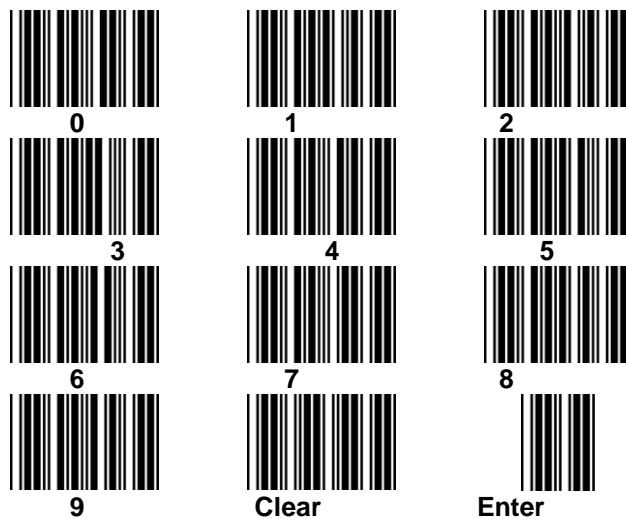

2D Optical Imaging Scanners

The **LT7250H** RF Terminals have a 2D imaging scan engine built in. This engine can read both 1D bar codes - with mainly vertical elements – like the UPC or Code 39 – in addition to reading 2D Matrix codes like QR, PD-417, DataMatrix & Maxicode bar codes. If you are using a 2D imager, technique is not critical. The scanners are “point-and-shoot”; you can’t miss. Upon triggering the engine sends a light pattern out with an aiming area to help locate the code in the beam, the imager processes the bar code data almost instantly for the fastest scanning in the industry.

To scan a bar code using your 2D scanner:

- Put your RF Terminal in One-Way mode with the host computer program not running.
- Point the scanner at the bar code at about 6” away.

Pull the trigger (or push the Scan Button on the Keypad) and line up aiming dot on the bar code. If you don’t get a read, vary the distance of the scanner from the bar code by pulling up or moving down. The scan should be instant.



ASCII Code Equivalent Table

The 128 ASCII codes, their 3-digit decimal equivalents and 2-digit hex equivalents are detailed in the below table.

char	hex	3 digit ASCII	char	hex	3 digit ASCII	char	hex	3 digit ASCII	char	hex	3 digit ASCII
NUL	00	000	SP	20	032	@	40	064	'	60	096
SOH	01	001	!	21	033	A	41	065	a	61	097
STX	02	002	"	22	034	B	42	066	b	62	098
ETX	03	003	#	23	035	C	43	067	c	63	099
EOT	04	004	\$	24	036	D	44	068	d	64	100
ENQ	05	005	%	25	037	E	45	069	e	65	101
ACK	06	006	&	26	038	F	46	070	f	66	102
BEL	07	007	'	27	039	G	47	071	g	67	103
BS	08	008	(28	040	H	48	072	h	68	104
HT	09	009)	29	041	I	49	073	i	69	105
LF	0A	010	*	2A	042	J	4A	074	j	6A	106
VT	0B	011	+	2B	043	K	4B	075	k	6B	107
FF	0C	012	,	2C	044	L	4C	076	l	6C	108
CR	0D	013	-	2D	045	M	4D	077	m	6D	109
SO	0E	014	.	2E	046	N	4E	078	n	6E	110
SI	0F	015	/	2F	047	O	4F	079	o	6F	111
DLE	10	016	0	30	048	P	50	080	p	70	112
DC1	11	017	1	31	049	Q	51	081	q	71	113
DC2	12	018	2	32	050	R	52	082	r	72	114
DC3	13	019	3	33	051	S	53	083	s	73	115
DC4	14	020	4	34	052	T	54	084	t	74	116
NAK	15	021	5	35	053	U	55	085	u	75	117
SYN	16	022	6	36	054	V	56	086	v	76	118
ETB	17	023	7	37	055	W	57	087	w	77	119
CAN	18	024	8	38	056	X	58	088	x	78	120
EM	19	025	9	39	057	Y	59	089	y	79	121
SUB	1A	026	:	3A	058	Z	5A	090	z	7A	122
ESC	1B	027	;	3B	059	[5B	091	{	7B	123
FS	1C	028	<	3C	060	\	5C	092		7C	124
GS	1D	029	=	3D	061]	5D	093	}	7D	125
RS	1E	030	>	3E	062	^	5E	094	~	7E	126
US	1F	031	?	3F	063	_	5F	095	DEL	7F	127

Full ASCII Equivalent Table